



*The manufacturer of high
efficient beveling systems*

*Fabricante de sistemas
de biselado de alta eficacia*

*Producteur de systèmes
de chanfreinage
extrêmement efficaces*



www.beveler.eu
www.bevelerUSA.com

B-LINE

hand held bevelling and deburring machines

pages 2 - 23



UZ-LINE

bevelling machines

with automatic feeding

pages 24 - 47



B-LINE

hand held bevelling and deburring machines

Type	Drive	Max. Bevel width
B2 AIR	pneumatic	2 mm / 0.08 in
B3	electric	3 mm / 0.12 in
B10 ELECTRA	electric	10 mm / 0.4 in
B15 ELECTRA	electric	15 mm / 0.6 in
B15 AIR	pneumatic	15 mm / 0.6 in
B-Dock	(accessory for B10 ELECTRA, B15 ELECTRA)	5 mm / 0.2 in
Xpipe Beveler	(accessory for B10 ELECTRA, B15 ELECTRA, B15 AIR)	15 mm / 0.6 in
B22 ZERO	electric	20 mm / 0.83 in



Bevel angle	Rounding of the edge	Feeding	Page
-------------	----------------------	---------	------

45°	R 1,5 mm 0.04 in	manual	4 - 5
-----	---------------------	--------	-------



GREAT
ERGONOMICS

30° - 60°	no	manual	6 - 7
-----------	----	--------	-------



30°, 37,5°, 45° 50°, 60°	R 2,5 mm / 0.08 in R 3,5 mm / 0.12 in R 4 mm / 0.16 in	manual	8 - 9
-----------------------------	--	--------	-------



30°, 37,5°, 45° 50°, 60°	R 2,5 mm / 0.08 in R 3,5 mm / 0.12 in R 4 mm / 0.16 in	manual	10 - 11
-----------------------------	--	--------	---------



30°, 37,5°, 45° 50°, 60°	R 2,5 mm / 0.08 in R 3,5 mm / 0.12 in R 4 mm / 0.16 in	manual	12 - 13
-----------------------------	--	--------	---------



30°, 37,5°, 45° 50°, 60°	R 2,5 mm / 0.08 in R 3,5 mm / 0.12 in R 4 mm / 0.16 in	manual	16 - 17
-----------------------------	--	--------	---------



SMART
ACCESSORY

30°, 45°, 60°	R 2,5 mm / 0.08 in R 3,5 mm / 0.12 in R 4 mm / 0.16 in	manual	18 - 19
---------------	--	--------	---------



NEW PRODUCT!
SMART ACCESSORY

0° - 60° FACING	no	manual	22 - 23
-----------------	----	--------	---------



APPLICATION
FACING 0°



B2 AIR deburring system

Maximum bevel width 2 mm / 0.08 in. Edge rounding function.

B2 Air

Art. Nr. 24200



Ergonomic body of the machine

Weight only 400g

Precise scale of machining depth adjustment



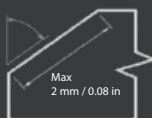

Designed for deburring and rounding edges of steel, stainless steel, aluminum and other workpieces. Suitable for machining holes from the internal diameter of 7 mm / 0.27 in.

- Compact design, great ergonomics
- Weight only 400 g / 0.88 lb
- Edge machining by rounding R1.5 mm / 0.06 in - edge preparation before painting
- Powerful and reliable pneumatic drive
- Precision machining scale for more precise machining
- Packed in a cardboard box

Technical data:

Bevel angle:	45°
Bevel width (hypotenuse):	2 mm / 0.08 in as a maximum
Rounding radius:	R 1,5 mm / 0.06 in
Speed	23,000 rpm.
Feeding:	manual
Air consumption	320 l/min
Dimensions:	112 x 60 x 48 mm / 4.4 x 2.36 x 1.9 in
Weight:	400 g / 0.88 lb
Number of cutting inserts:	3 pcs

Included in price:

B2 AIR deburring system - fitted with head with cutting inserts.
Tools for an operator.
User manual.

Machine name:

Art. Nr.

B2 AIR deburring system - fitted with head with cutting inserts

24200



Accessories:

Art. Nr.

ECO Inserts B2 AIR (pack of 10 pcs)	24201
Inserts radius R1.5mm / 0.06 in (pack of 10 pcs)	24202
PREMIUM Inserts B2 AIR, coated (pack of 10 pcs)	24204
Pneumatic set with quick couplings (contains: FRL - filtration, regulator and lubrication unit, quick couplings, hoses 10 m)	24203
Screw for the inserts	7252F-04
Milling head	24205



Art. Nr. 24203



Art. Nr. 24201



Art. Nr. 24204



Art. Nr. 24202

B3

Precise guidance

Art. Nr. 28220 (3 Phase - 400 V)
Art. Nr. 28211 (1 Phase - 110 V)

Setting of deburring angle

Machining depth adjustment

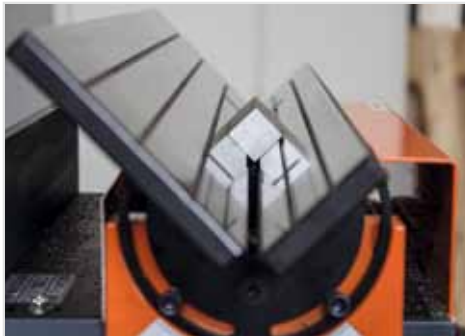

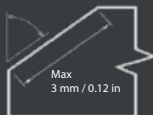

Designed for deburring and bevelling of steel parts and workpieces. Processing of different types of materials. Solid and stable machine design.

- Scale for machining depth adjustment
- Protective safety covers
- Adjustable machining angle
- For steel, stainless steel, aluminum and other materials
- Precise, massive and over-long plate fences
- Packed in a cardboard box

Technical data:

Bevel angle:	30° - 60° continuously adjustable
Bevel width:	0 - 3 mm / 0.12 in - 400 MPa / 58 015 PSI
Motor:	1300 W
Speed:	3 600 rpm
Feed:	manual
Weight:	31 kg / 68 lb
Dimensions:	530 x 420 x 410 mm / 21 x 16.5 x 16.1 in
Number of cutting tips:	5 pcs (four-sided)

Included in price:

Bevelling system complete - fitted with head and cutting inserts.
 Supply cable without a plug.
 Tools for an operator.
 User manual.

Machine name:	Art. Nr.
Deburring and bevelling system B3 (3 Phase - 400 V)	28220
Deburring and bevelling system B3 (1 Phase - 110 V)	28211

Accessories:	Art. Nr.
Replacement cutting head (fitted with cutting inserts)	28221
Coated Cutting inserts (pack of 10 pcs)	25909



Art. Nr. 28221



Art. Nr. 25909

B10 Electra

High Performance
Motor and Gearbox



Art. Nr. 25300 (1 Phase - 220 V)
Art. Nr. 25301 (1 Phase - 110 V)





**Designed for beveling and deburring workpieces, internal and external radiuses and holes.
Specially designed for producing bevels and welding preparation.**

Durable and stable machine design without compromises.

Thanks to the special design of the cutting head you will you save ½ inserts at reductions of up to 8 mm / 0.31 in of the bevel width.

- Scale for an accurate bevel size adjustment
- For beveling and deburring steel, aluminum and other materials
- Replaceable head for changing bevel angle
- Handheld powerful equipment
- Electronic Speed Control
- Edge rounding function, preparation before surface treatment
- Packed in a cardboard box

Technical data:

Bevel angle:	replaceable head 30°, 37,5°, 45°, 50°, 60°- other angles on demand
Bevel width:	0 to 10mm / 0 to 0.4 in < 400 MPa / 58 015 PSI 0 to 5mm / 0 to 0.2 in > 400 MPa / 58 015 PSI
Rounding app:	R 2,5 mm, R 3,5 mm, R 4 mm / R 0,1 in, R 0,14 in, R 0,16 in
Engine:	1700 W
Speed:	2700 - 8 500 rpm
Overload protection:	thermal
Feed:	manual
Weight:	6 kg / 13.2 lb

Included in price:

Beveling and deburring system B10 ELECTRA (without the head).
Tools for an operator.
User manual.

Machine name:	Art. Nr.
The B10 ELECTRA beveling and deburring system (1 Phase - 220 V)	25300
The B10 ELECTRA beveling and deburring system (1 Phase - 110 V)	25301

Accessories:	
Milling heads	see page 14-15
B-Dock (Beveler B10 Electra is not included)	see page 16-17 (and price advantage sets page 20-21)
Xpipe Beveler (Beveler B10 Electra is not included)	see page 18-19 (and price advantage sets page 20-21)
Grinding adapter Edge Cleaner	see page 14
Special lubricating paste for the milling heads. Prevents seizing up, wear, cold-welding, solidifying of the threads 120g.	Art. Nr. 33005
Universal tube key (for milling head' s removing)	Art. Nr. 25300.27



Xpipe Beveler



B-Dock



Edge Cleaner



Cutting inserts



Milling heads



Rounding milling heads



Cutting inserts



Universal tube key

B15 Electra



High Performance
Motor and Gearbox

REVOLVING ERGONOMIC HANDLE



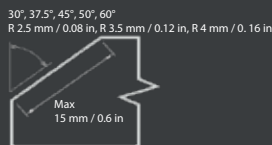

Designed for bevelling and deburring of parts, internal and external radiuses and holes. Specially designed for producing visual bevel and welding preparation. Powerful electric drive for extreme loads.

- Scale for an accurate bevel size adjustment
- For bevelling and deburring of steel, aluminum and other materials
- Replaceable head for changing bevel angle
- Handheld powerful equipment
- Swivelling ergonomic handle
- Edge rounding function, preparation before surface treatment
- Packed in a cardboard box

Technical data:

Bevel angle: Replaceable head 30°, 37,5°, 45°, 50°, 60°- other angles on demand
 Bevel width: 0 to 15 mm / 0 to 0.6 in < 400 MPa / 58 015 PSI
 0 to 8 mm / 0 to 0.3 in > 400 MPa / 58 015 PSI
 Rounding app: R 2,5 mm, R 3,5 mm, R 4 mm / R 0,1 in, R 0,14 in, R 0,16 in
 Engine: 2500 W / 2000W
 Speed: 6600 rpm
 Weight: 9.5 kg / 20.9 lb

Included in price:

Bevelling and deburring system B15 ELECTRA (without the head).
 Tools for an operator.
 User manual.

Machine name:

Art. Nr.

Bevelling and deburring system B15 ELECTRA (1 Phase - 220 V)	25250
Bevelling and deburring system B15 ELECTRA (1 Phase - 110 V)	25251

Accessories:

Milling heads	see page 14-15
B-Dock (Beveler B15 Electra is not included)	see page 16-17 (and price advantage sets page 20-21)
Xpipe Beveler (Beveler B15 Electra is not included)	see page 18-19 (and price advantage sets page 20-21)
Grinding adapter Edge Cleaner	see page 14
Special lubricating paste for the milling heads. Prevents seizing up, wear, cold-welding, solidifying of the threads 120g.	Art. Nr. 33005
Universal tube key (for milling head' s removing)	Art. Nr. 25300.27



Xpipe Beveler



B-Dock



Edge Cleaner



Cutting inserts



Milling heads



Rounding milling heads



Cutting inserts



Universal tube key



Bevelling system B15 AIR (B15 AIR-S)

Maximum bevel width 15 mm / 0.6 in. Edge rounding function.

B15 Air

Powerful 2984 W pneumatic motor

Heavy-duty design

Machining depth adjustment



Low RPM version
B15 Air-S
for Stainless



Art. Nr. 27220 (B15 AIR)
Art. Nr. 27220S (B15 AIR-S)



HEAVY-DUTY





Designed for bevelling and deburring of straight and shaped parts, internal and external radiuses and holes. Specially designed for producing visual bevels and welding preparation. Powerful pneumatic drive for extreme loads.

- Scale for an accurate bevel size adjustment
- For bevelling and deburring of steel, aluminum and other materials
- Replaceable head for changing bevel angle
- Powerful handheld equipment
- Also suitable for explosion-risk operations
- Edge rounding function, preparation before surface treatment
- Low RPM model for processing of stainless steel
- Packed in a cardboard box

Technical data:

Bevel angle:	Replaceable head 30°, 37,5°, 45°, 50°, 60°- other angles on demand
Bevel width:	0 to 15 mm / 0 to 0.6 in < 400 MPa / 58 015 PSI 0 to 8 mm / 0 to 0.31 in > 400 MPa / 58 015 PSI
Engine:	Pneumatic
Engine Power:	2984 W
Speed:	B15 AIR: 6000 rpm / B15 AIR-S: 4200 rpm
Air consumption (full load):	B15 AIR: 2050 l/min / B15 AIR-S: 1660 l/min
Air consumption (no load):	B15 AIR: 960 l/min / B15 AIR-S: 510 l/min
Operating pressure:	6 bar / 87.02 PSI
Weight:	7,5 kg / 16.5 lb

Included in price:

B15 AIR bevelling and deburring system (without the head).
Tools for an operator.
User manual.

Machine name:	Art. Nr.
Bevelling and deburring system B15 AIR	27220
Bevelling and deburring system B15 AIR-S	27220S

Accessories:

Milling heads	see page 14-15
Xpipe Beveler (Beveler B15 Air is not included)	see page 18-19 (and price advantage sets page 20-21)
Grinding adapter Edge Cleaner	see page 14
Pneumatic set with quick couplings (contains: FRL - filtration, regulator and lubrication unit, quick couplings, hoses 10 m)	Art. Nr. 27221
Special lubricating paste for the milling heads. Prevents seizing up, wear, cold-welding, solidifying of the threads 120g.	Art. Nr. 33005
Universal tube key (for milling head´s removing)	Art. Nr. 25300.27



Xpipe Beveler



Pneumatic set



Edge Cleaner



Cutting inserts



Milling heads



Rounding milling heads



Cutting inserts























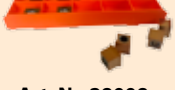

Universal tube key

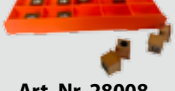

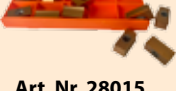

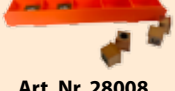

The Premium milling heads for processing tougher materials.

- For B10 Electra, B15 Electra and B15 AIR hand held bevelers
- Developed especially for stainless steel and other tougher materials
- More effective increased safety
- Smoother final surface and higher lifetime for the cutting inserts
- Longer cutting inserts (15 mm/0.6") are standard and two-sided
- Shorter cutting inserts (8 mm/0.3") are four-sided » double lifetime

Required bevel angle	The starter kit Premium milling head max 15 mm/0.6" two sided cutting inserts	The spare two sided cutting inserts 15 mm/0.6"	The additional special roller for shorter cutting inserts 8 mm/0.3" (the milling head stays original)	The shorter four sided cutting inserts 8 mm/0.3"	The fastening screws for the cutting inserts (works with both cutting inserts versions)
30°	 Art. Nr. 27223X (the cutting inserts and the lead roller Ø 30 mm / 1.19" are included)	 Art. Nr. 28015 (10pcs package)	 Art. Nr. 28004 (complete special lead roller Ø 33,5 mm / 1.32" for shorter cutting inserts)	 Art. Nr. 28008 (10pcs package)	 Art. Nr. 28007 (1pc)
37.5°	 Art. Nr. 27227X (the cutting inserts and the lead roller Ø 26 mm / 1.02" are included)	 Art. Nr. 28015 (10pcs package)	 Art. Nr. 28013 (complete special lead roller Ø 30,5 mm / 1.2" for shorter cutting inserts)	 Art. Nr. 28008 (10pcs package)	 Art. Nr. 28007 (1pc)
45°	 Art. Nr. 27222X (the cutting inserts and the lead roller Ø 26 mm / 1.02" are included)	 Art. Nr. 28015 (10pcs package)	 Art. Nr. 28005 (complete special lead roller Ø 31 mm / 1.23" for shorter cutting inserts)	 Art. Nr. 28008 (10pcs package)	 Art. Nr. 28007 (1pc)
50°	 Art. Nr. 27224X (the cutting inserts and the lead roller Ø 26 mm / 1.02" are included)	 Art. Nr. 28015 (10pcs package)	 Art. Nr. 28014 (complete special lead roller Ø 31,5 mm / 1.24" for shorter cutting inserts)	 Art. Nr. 28008 (10pcs package)	 Art. Nr. 28007 (1pc)
60°	 Art. Nr. 27240X (the cutting inserts and the lead roller Ø 19 mm / 0.75" are included)	 Art. Nr. 28015 (10pcs package)	 Art. Nr. 28006 (complete special lead roller Ø 25,5 mm / 1.01" for shorter cutting inserts)	 Art. Nr. 28008 (10pcs package)	 Art. Nr. 28007 (1pc)
Other angles on demand					

Edge Cleaner - grinding adapter









Edge Cleaner - grinding adapter (including 10pcs grinding rings grain 40, 1pc guiding roller)	Grinding rings, grain 40 (pack 50pcs)	Spare polyurethane guiding roller
 Art. Nr. 25310 	 Art. Nr. 25312	 Art. Nr. 25311

Milling Heads and other accessories for B10 Electra, B15 Electra and B15 Air



The Rounding milling heads

- For B10 Electra, B15 Electra and B15 AIR hand held bevelers
- Smoother final surface and higher lifetime for the cutting inserts
- For edge rounding application

Required radius	Complete radius milling head, including of the guiding roll and fastenig screw	Radius 4 - sided cutting inserts	The fastening screws for the cutting inserts
R 2.5 mm / 0.08 in	 <p>Art. Nr. 27234X (the cutting inserts and the lead roller Ø 37 mm / 1.46" are included)</p>	 <p>Art. Nr. 26109 (10pcs package)</p>	 <p>Art. Nr. 28007 (1pc)</p>
R 3.5 mm / 0.12 in	 <p>Art. Nr. 27233X (the cutting inserts and the lead roller Ø 37 mm / 1.46" are included)</p>	 <p>Art. Nr. 26110 (10pcs package)</p>	 <p>Art. Nr. 28007 (1pc)</p>
R 4 mm / 0.16 in	<p>Compatible with the milling head R 3.5 mm / 0.12"</p> <p>Art. Nr. 27233X</p>	 <p>Part no. 26111 (10pcs package)</p>	 <p>Part no. 28007 (1pc)</p>

The older ECO milling heads. Available while supplied last.

	Art. Nr.
30° cutting head (including inserts, screws, bolts and roller). Guide roller diameter Ø 34 mm / 1.34 in	27223
50° cutting head (including inserts, screws, bolts and roller). Guide roller diameter Ø 28 mm / 1.10 in	27224
Coated cutting inserts - four-sided (pack of 10 pcs)	27231
Screw for the inserts	27241

Lubricating paste

	Art. Nr.
Special lubricating paste for the milling heads. Prevents seizing up, wear, cold-welding, solidifying of the threads 120g.	33005
Universal tube key (for milling head' s removing)	25300_27
Magnetic sweeper Mag Brush	18654



Art. Nr. 27223

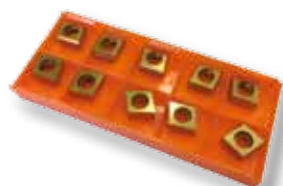

Art. Nr. 27231



B-Dock

Compatible with B10 Electra and B15 Electra

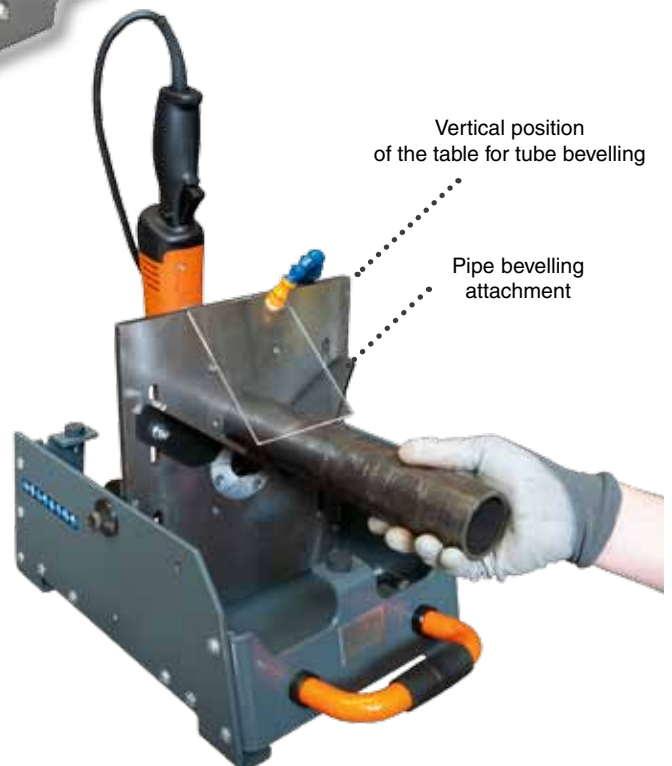
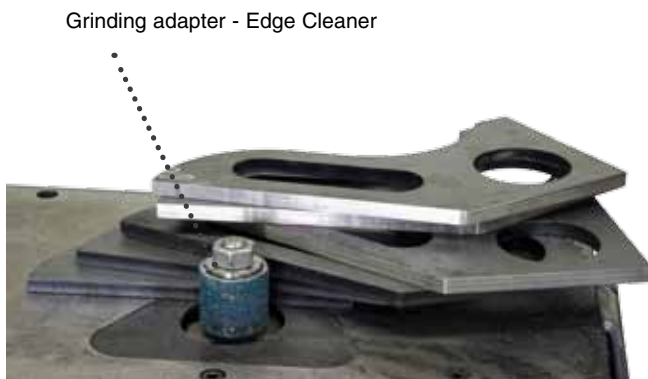



Dock station B-Dock enables the B-Line Machine (B10, B15 Electra) to be used stationary. It is designed for beveling small workpieces which would be hard or impossible to clamp and bevel the standard way. The system retains all advantages of the hand-held B-Line Machines (B10, B15 Electra). The B-dock system makes it possible to bevel irregular shapes, straight workpieces and holes. Radiused edges are also possible with the radius milling head. Specialty guide attachments and an easy, vertical worktable adjustment allow for beveling of pipe and tube.

By purchasing the set B-Dock + B10 or B15 Electra you are getting a universal beveling system.

- Tilting table for easy attachment of B10, B15 Electra
- Vertical position of the table for convenient pipe beveling
- Straight edge and pipe guide attachments included in the price
- Adjustable protection shield increases work safety
- Robust design for precision beveling and durability of the B-dock
- The Hardox work surface is wear resistant
- Light weight system is easy to transport
- Can be used with B15 Electra or B10 Electra machines
- Packed in a cardboard box

Technical data:

Bevel angle: see previous page (technical data for B10, B15 Electra)
 Bevel width: 0 to 5mm / 0 to 0.2 in
 Rounding app: see previous page (technical data for B10, B15 Electra)
 Motor: see previous page (technical data for B10, B15 Electra)
 RPM: see previous page (technical data for B10, B15 Electra)
 Feed: manual
 Weight: 28kg / 62 lb
 Dimensions: 443 x 368 x 220mm / 17,5 x 14,5 x 8,7 in

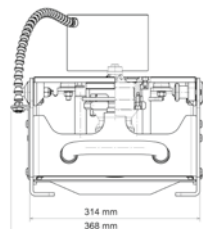
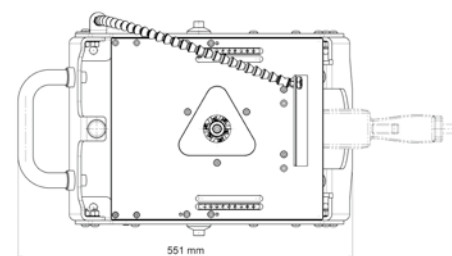
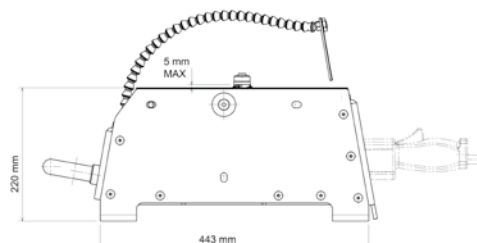

Included in price:

- Dock station B-dock (without bevelling machine)
- Tools for an operator
- Manual

Machine name:

The Beveling System B-Dock (without bevelling machine)

Art. Nr.

25350

Accessories:

- Head cover for radius heads
- Protection felt plug

Art. Nr.

25350.6RT
25315

Cost effective sets, see page 20-21



Pipe beveling attachment



Straight edge beveling guide



Protection felt plug



Head cover





Xpipe Beveler (accessory for B-Line Machines)
Maximum bevel width 15 mm / 0.6 in. (10mm / 0.4 in.)
Edge rounding function.

Xpipe Beveler

Compatible with B10 Electra, B15 Electra and B15 Air

Ergonomic, rotating handle
increases work productivity

The bevel depth can be set
continuously

Lightweight aluminum construction
of the machine frame

Special one-way bearings for the roller
shutters prevent any kickback

The Beveling Machine
is not included with
Xpipe Beveler

Art. Nr. 25500



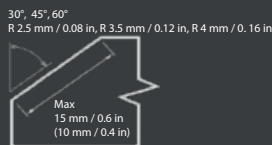

Bevelling tool for easy and fast machining of pipes from Ø 85 mm (3.36").
The maximum diameter of the pipe is not limited, and the tool can be used on flat materials.
The unique mechanism of clamping, guiding rollers ensures precise and comfortable guiding around the circumference of the machined pipe or along the edge of the sheet metal.
The robust frame of the body guarantees constant cut with a minimum of possible vibrations and uncompromising stability of the selected bevel angle.

- Designed to work with B10 Electra, B15 Electra and B15 AIR bevelling machine
- Continuous bevel depth setting, built-in scale
- Special one-way bearings preventing kickback of approaching material, safe and comfortable beveling
- The set removal value can be ensured, and a constant chamfer depth can be guaranteed even on a larger number of pipes
- Unique, flexible mounting of the running rollers, suitable for any unevenness and inaccuracies around the circumference of the pipe
- Lightweight aluminum construction of the machine frame guarantees comfortable handling of the product
- Ergonomic, rotating handle for productivity and safety
- Safety cover for flying chips, preventing possible injuries
- Packed in a plastic box

Technical data:

Bevel angle: 30°, 45° and 60°
 Bevel width: 10 mm / 0.39" (with B10 Electra)
 15 mm / 0.60" (with B15 Electra and B15 AIR)
 Rounding app: R 2,5 mm / R 0.10", R 3,5 mm / R 0.137", R4 mm / R 0.157"
 Minimum ID (outside machining): > Ø 85 mm / 3.36"
 Wall thickness (outside machining): 2,5 - 15 mm / 0.10" - 0.60"
 Minimum ID (inside machining): > Ø 500 mm / 19.7" (smaller Ø on request)
 Wall thickness (inside machining): 5 - 15 mm / 0.20" - 0.60"
 Minimum clamping depth: 80 mm / 3.15"
 Thickness working (flat bevelling): 3 - 20 mm / 0.11" - 0.78"
 Feeding: manual
 Weight (without the machine): 8,4 kg/18.5 lb.

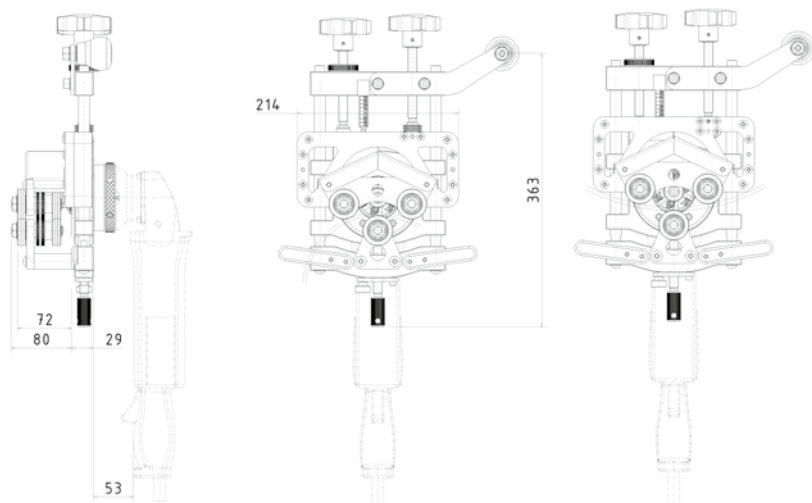

Included in price:

- Xpipe Beveler (without bevelling machine)
- Tools for an operator
- User manual

Cost effective sets, see page 20-21

Machine name:

The Xpipe Beveler (without bevelling machine)

Art. Nr.

25500





B-Line sets!

Compactible accessories for B10 Electra, B15 Electra and B15 Air



Cost effective accessories sets for B10 Electra, B15 Electra and B15 Air.



These accessories will transform your B-line into a versatile tool, which can handle most of your future projects.

You can bevel flat steel, or tubes, small workpieces or you can do rounding of the plate edges. All in one solution!

<i>B10 Electra sets</i>	Set 230V	Set 120V
 <p>B10 Electra + B-Dock</p>	Art. Nr. 25302	Art. Nr. 25303
 <p>B10 Electra + Xpipe Beveler</p>	Art. Nr. 25304	Art. Nr. 25306
 <p>B10 Electra + B-Dock + Xpipe Beveler</p>	Art. Nr. 25305	Art. Nr. 25307



B15 Electra sets		Set 230V	Set 120V
 <p>B15 Electra + B-Dock</p>		Art. Nr. 25252	Art. Nr. 25253
 <p>B15 Electra + Xpipe Beveler</p>		Art. Nr. 25254	Art. Nr. 25256
 <p>B15 Electra + B-Dock + Xpipe Beveler</p>		Art. Nr. 25255	Art. Nr. 25257

B15 Air sets		Pneumatic powered
 <p>B15 Air + Xpipe Beveler</p>		Art. Nr. 27225
 <p>B15 Air - S + Xpipe Beveler</p>		Art. Nr. 27225S

B22 Zero



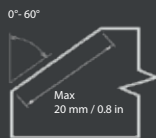

Designed for bevelling and deburring straight edges, for the so-called FACING - removing an unwanted layer of materials on the workpiece edge resulting from cutting the metal sheet by burning. Specially designed for the production of visual bevels and welding preparation. Powerful electric drive for extreme loads.

- High-performance motor
- The possibility of continuous adjustment of the working angle in the range of 0° - 60°
- FACING - edge processing at an angle of 0° to remove unwanted material layer after burning cutting
- The unique scaling mechanism of the bevel size for increased precision
- A very compact and ergonomic design for high labor productivity
- All-round frame for damage protection and for grip options
- With the appropriate equipment, pipes and tubes can be bevelled from Ø 150 mm / 5.9 in
- Additional adjustable handle
- Packed in a cardboard box

Technical data:

Bevel angle: continuously adjustable between 0° - 60°
 Bevel width: 0 to 20 mm / 0 to 0.79 in < 400 MPa / 58 015 PSI
 0 to 16 mm / 0 to 0.63 in > 400 MPa / 58 015 PSI
 Engine: 1100 W
 Speed: 2850 rpm
 Weight: 19,5 kg / 43 lb
 Number of inserts: 10 pcs

Included in price:

Bevelling and deburring system B22 ZERO.
 Tools for an operator.
 User manual.

Machine name:	Art. Nr.
Bevelling and deburring system B22 ZERO (1Phase - 230 V)	29220
Bevelling and deburring system B22 ZERO (3Phase - 220 V)	29212
Bevelling and deburring system B22 ZERO (3Phase - 480 V)	29211
Bevelling and deburring system B22 ZERO (1Phase - 120 V)	29221

Accessories:	Art. Nr.
Standard cutting head (including inserts and screws)	29201
Standard cutting inserts (pack of 10 pcs)	29203
Premium cutting head - designed for selected stainless steel materials (including inserts and screws)	29202
Premium cutting inserts (pack of 10 pcs)	29205
Additional adjustable handle	29206
Pipe and tube bevelling from Ø 150 mm	29204
Screw for the inserts	29200.9300



Art. Nr. 29201



Art. Nr. 29206



Art. Nr. 29202



Art. Nr. 29204



Art. Nr. 29203

UZ-LINE

beveling machines with automatic feeding

Type	Drive	Max. Bevel width
UZ12 ULTRALIGHT	electric	12 mm / 0.47 in
UZ15 RAPID	electric	15 mm / 0.6 in
UZ15 RAPID + 3D manipulator set	electric	15 mm / 0.6 in
UZ18 HARDWORKER	electric	18 mm / 0.7 in
UZ18 HARDWORKER + 3D manipulator set	electric	18 mm / 0.7 in
UZ29 SPEEDER	electric	29 mm / 1.14 in
UZ30 EXPRESS	electric	30 mm / 1.18 in
UZ50 TRIUMPH	electric	62 mm / 2.44 in
UZ50 TRIUMPH +UZP 30 set	electric	30 mm / 1.18 in



Why High speed
beveling?



Bevel angle	Rounding of the edge	Feeding	Page	
22,5° , 30° , 37,5° 45° , 50°	no	autofeed	26 - 27	 The lightest with autofeed
15° - 50°	no	autofeed	28 -29	
15° - 50°	no	autofeed	30 - 31	
15° - 50°	no	autofeed	32 - 33	 Heavy - duty
15° - 50°	no	autofeed	34 - 35	
22,5° , 30° , 37,5° 45° , 50°	no	autofeed	36 - 37	 Bevel width 18 mm in first cut!
30° - 60°	no	autofeed	38 - 39	
15° - 60°	no	autofeed	40 - 41	 HARDOX, STAINLESS steel Beveling
15° - 60°	no	autofeed	42 - 43	

UZ12 Ultralight



**Incredibly
quiet operation**



**3 BEVELERS
IN ONE**

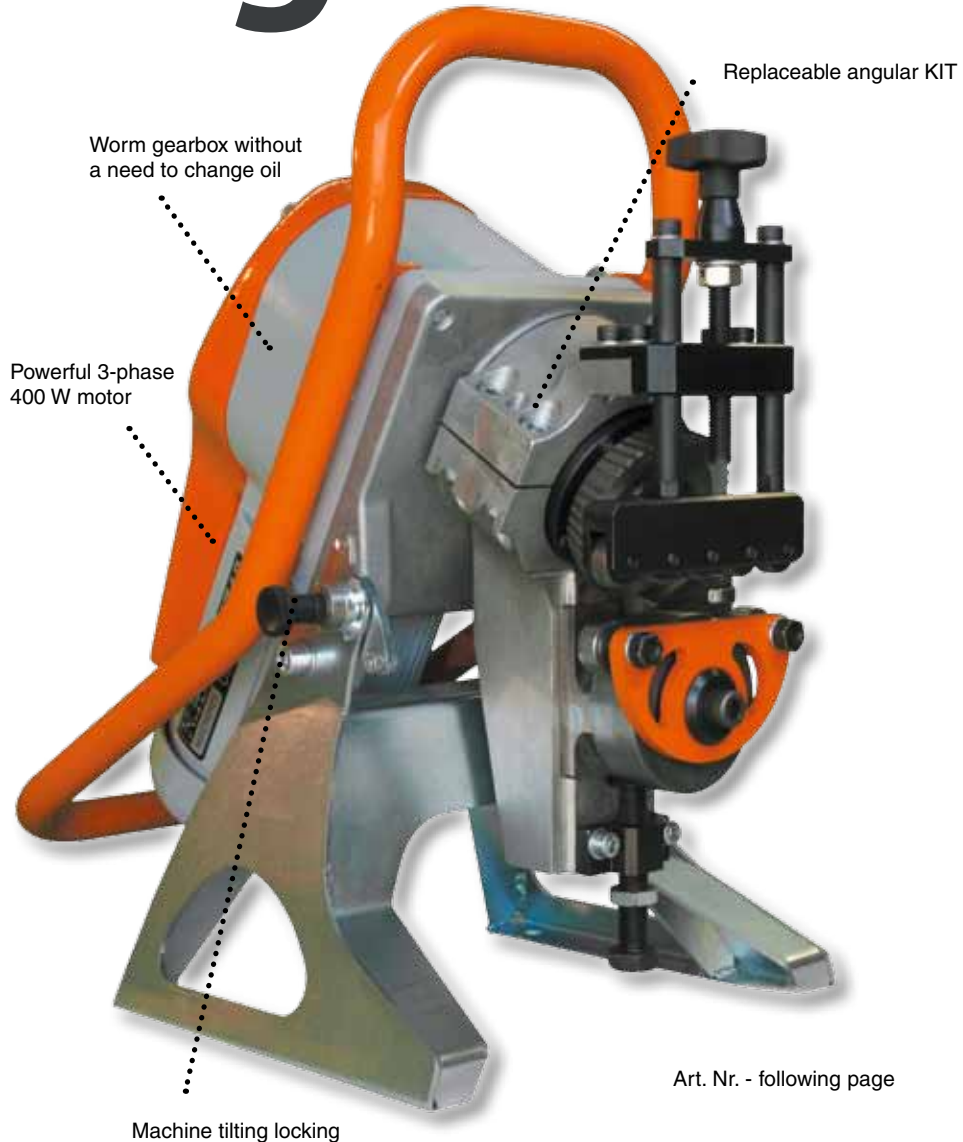

Art. Nr. - following page





The UZ12 ULTRALIGHT is one of the lightest bevelling machines with the automatic feed in the market. Thanks to its compact size and low weight it is perfect not only for workshops but also for assemblies. The machine is equipped with the automatic feed. Working with UZ12 ULTRALIGHT is therefore very comfortable. The quietest bevelling system on the market.

- For conventional steel (up to strength of 600 MPA / 87 022 PSI), brass, copper and aluminum materials
- For bevelling material with minimum dimensions - width 65 mm / 2.56 in, length 60 mm / 2.36 in, thickness 3 mm / 0.12 in
- Thickness of bevelled material 3 - 35 mm / 0.12 - 1.37 in
- Bevelling of pipes from the internal Ø 95 mm / 3.74 in
- Variable bevel angle with replaceable arms/kits for each given angle
- Double-sided bevel (X, K) without the need for material handling
- Surprisingly silent drive.
- Equipped with an automatic feed
- Stationary or mobile use
- The machine works with large workpieces without any support. Speed 1.8 m/min / 5.9 ft/min
- Smaller parts of the material are inserted directly into the machine
- Lightweight and compact design. Single operator machine
- Thermal protection of the motor
- Packed in a wooden crate



3D adaptive system



Art. Nr. 1930

Technical data:

Max. bevel width:	12 mm / 0.47 in
Bevel angle:	30°, 45°, 22.5°, 37.5°, 50° (replaceable KIT)
Thickness of bevel. material:	3 - 35 mm / 0.12 - 1.37 in
Engine:	400 W
Feed:	1,8 m/min. / 5.9 ft/min.
Weight:	30 kg / 66 lb
Dimensions:	470 x 294 x 523 mm / 18.5 x 11.57 x 20.59 in

Included in price:

Bevelling system UZ12 ULTRALIGHT.
Tools for an operator.
User manual.

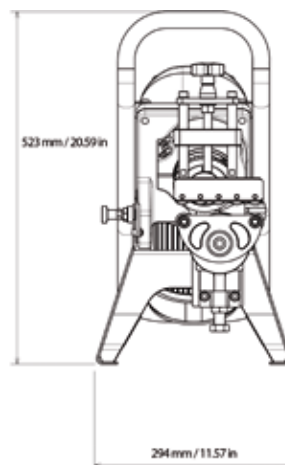
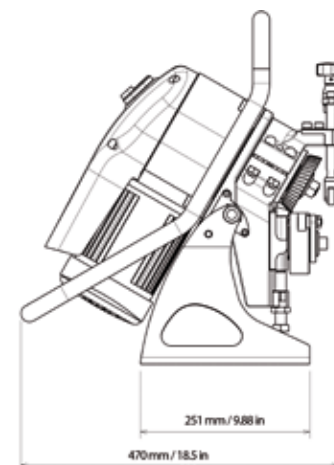
 Art. Nr. - 400V
3 phase

 Art. Nr. - 480V
3 phase

 Art. Nr. - 220V
3 phase

Machine name:	Art. Nr. - 400V 3 phase	Art. Nr. - 480V 3 phase	Art. Nr. - 220V 3 phase
Bevelling system UZ12 ULTRALIGHT - set (KIT 30° + 45°)	1922	1819	1913
Bevelling system UZ12 ULTRALIGHT - set (KIT 22,5° + 30° + 37,5° + 45° + 50° + pipe bevelling tool)	1918	1818	1912

Accessories:

	Art. Nr.
ECO cutting tool - suitable for conventional steel	1927
ECO cutting tool - suitable for conventional steel - 2 + 1 free set	1928
PVD cutting tool - suitable for tougher materials	1916
PVD cutting tool - suitable for tougher materials - 2 + 1 free set	1935
Separate KIT 22.5°	1926
Separate KIT 30°	1923
Separate KIT 37.5°	1925
Separate KIT 45°	1924
Separate KIT 50°	1929
Pipe and tube bevelling fixture from Ø 95 mm / 3.74 in (internal diameter)	1919
3D Manipulator - allows you to rotate the machine by 180° thus creating a two-sided bevel and facilitates the machine transport at the workplace.	1930
Adapter for connecting UZ 12 Ultralight with the 3D Manipulator	1911
Bevelling Solver - a portable calculator for cutting calculations for N.KO Machines (see page 44 - 45)	1900



UZ15 Rapid



Incredibly quiet operation



3D adaptive system



3 BEVELERS
IN ONE

Art. Nr. 1931 (3 Phase - 400 V)
Art. Nr. 1934 (3 Phase - 480 V)
Art. Nr. 1933 (3 Phase - 220 V)

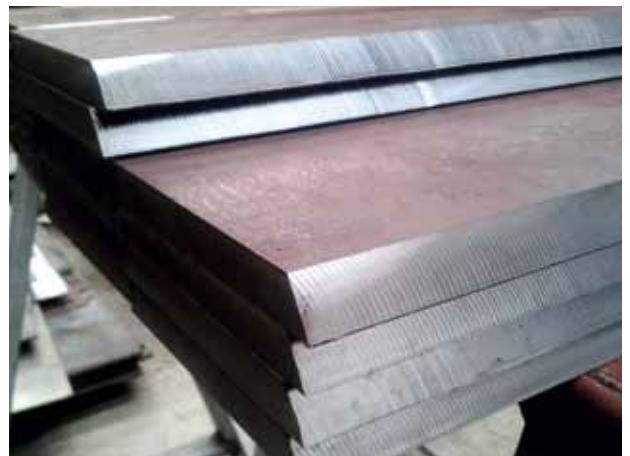
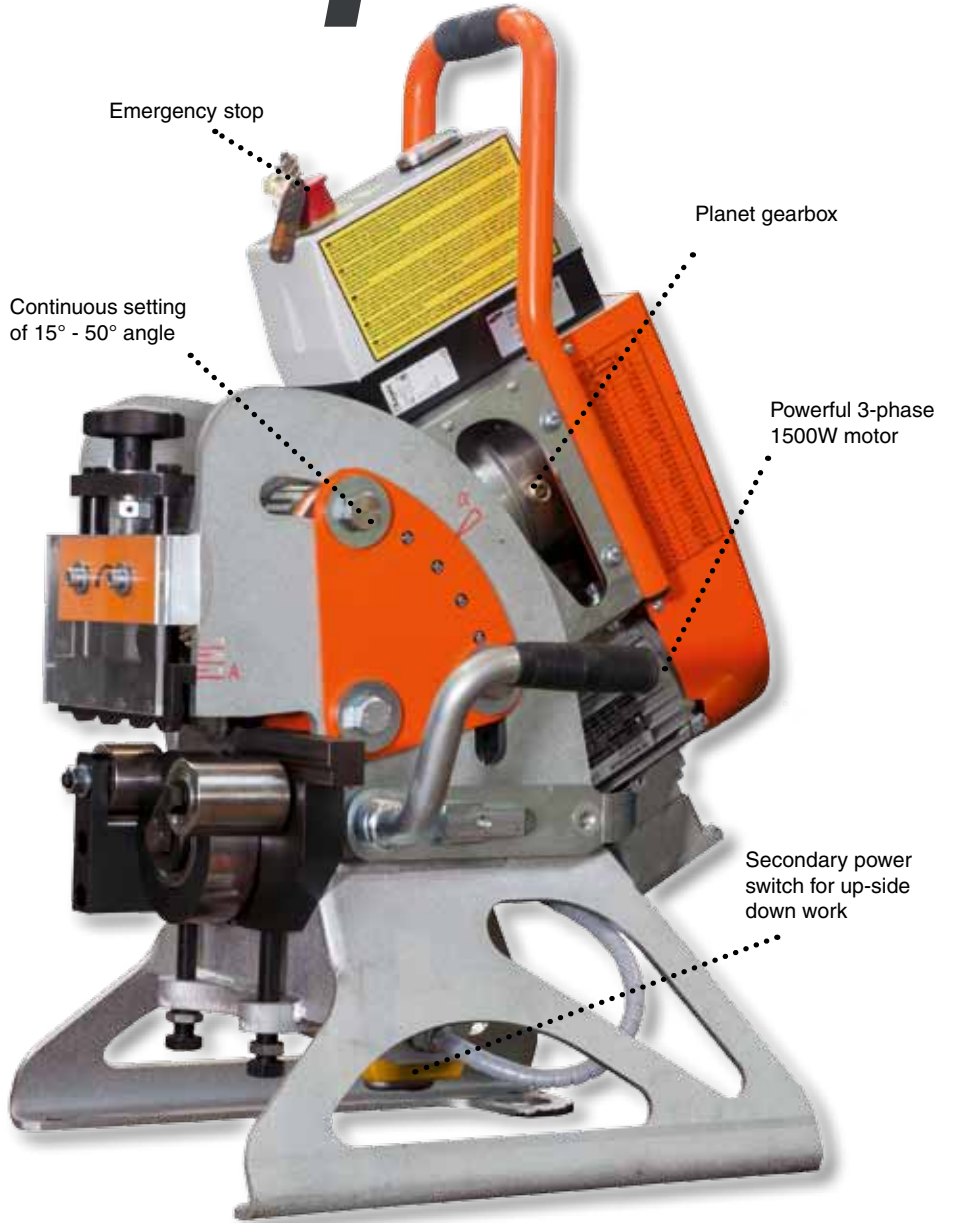

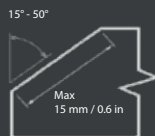

The UZ15 RAPID machine is one of the fastest automatic bevelling machines with the automatic feed on the market. It is suitable not only for workshops, but also for assembly operations. It has a continuous working angle adjustment system. In addition, the machine is equipped with an automatic feed. Working with UZ15 Rapid is therefore very comfortable.

- For conventional steel (up to 600 MPa / 87 022 PSI), brass, copper and aluminum
- For bevelling material with minimum dimensions - width 70 mm / 2.75 in, length 150 mm / 5.9 in, thickness 6 mm / 0.23 in
- Thickness of bevelled material 6 to 40 mm / 0.23 to 1.57 in
- The bevel angle easily adjustable from 15° to 50° smoothly, without the need to replace any part
- Capable of performing double-sided bevel (X, K) without the need for material handling
- Easy connection to the 3D Manipulator for easier operation and handling
- Equipped with an automatic feed
- Stationary or mobile use
- The machine works with large workpieces without any support. Speed of 3.5 m/min / 11.48 ft/min
- Smaller parts of the material are inserted directly into the machine
- Discounted price when purchasing UZ15 RAPID together with the 3D Manipulator
- Packed in a wooden crate

Technical data:

Max. bevel width:	15 mm / 0.6 in
Continuously adjustable angle:	15° - 50°
Thickness of bevelled material:	6 to 40 mm / 0.23 to 1.57 in
Engine:	1500 W
Feed:	3,5 m/min. / 11.48 ft/min.
Weight:	94 kg / 207 lb
Dimensions:	530 x 395 x 860 mm 20.9 x 15.5 x 33.9 in

Included in price:

UZ15 RAPID bevelling system.
Tools for an operator.
User manual.

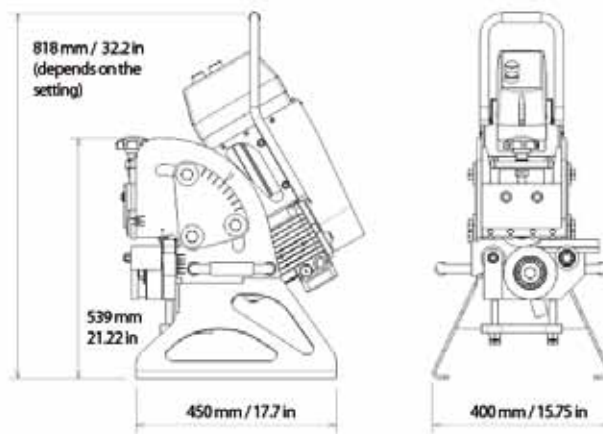

Machine name:

Art. Nr.

Bevelling system UZ15 RAPID (3 Phase - 400 V)	1931
Bevelling system UZ15 RAPID (3 Phase - 480 V)	1934
Bevelling system UZ15 RAPID (3 Phase - 220 V)	1933

Accessories:

Art. Nr.

ECO cutting tool - suitable for conventional steel	2137
ECO cutting tool - suitable for conventional steel - 2 + 1 free set	2134
PVD cutting tool - suitable for tougher materials	2142
PVD cutting tool - suitable for tougher materials - 2 + 1 free set	1936
PREMIUM Cutting Tool - coated TiN, suitable for conventional steel	2136
PREMIUM Cutting Tool - coated TiN, suitable for conventional steel - 2 + 1 free set	2132
3D Manipulator - allows to rotate the machine by 180° to create a two-sided bevel and facilitates the machine transport across the workplace.	1930
Bevelling Solver - a portable calculator for cutting calculations for N.KO Machines (see page 44 - 45)	1900



Art. Nr. 2136



Art. Nr. 2134



Art. Nr. 1900



Art. Nr. 2137



Art. Nr. 1936



3D adaptive system



Art. Nr. 1930



UZ15 Rapid + 3D manipulator set



Silent operation



3D adaptive system



**3 BEVELERS
 IN ONE**

Art. Nr. 1932 (3 Phase - 400 V)
 Art. Nr. 1937 (3 Phase - 480 V)
 Art. Nr. 1938 (3 Phase - 220 V)

Rotary mechanism allows to perform double-sided bevelling without the need for material handling.

Machine position height adjustment.

3D adaptive system compensates for inequalities of floor and allows for machine positioning according to the situation at a workplace

Quick connect machine system

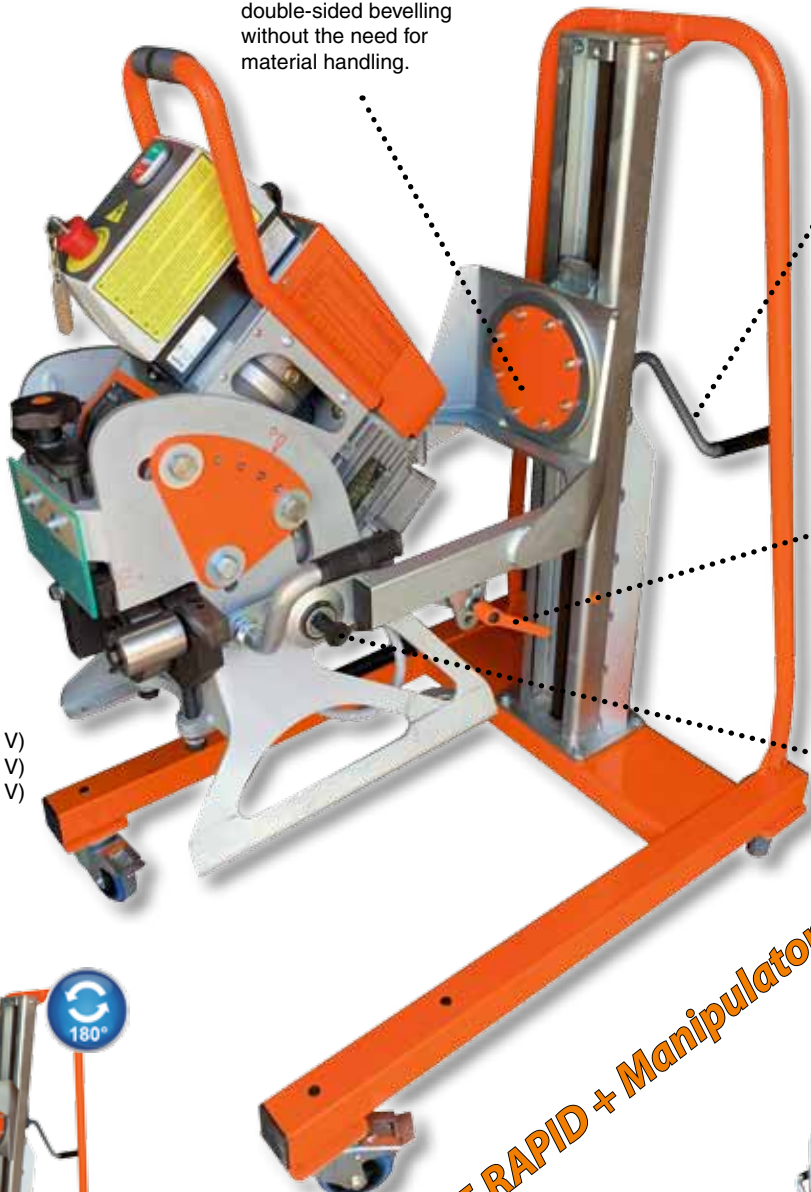

set UZ 15 RAPID + Manipulator 3D



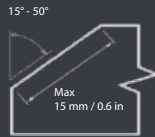

The UZ15 RAPID machine is one of the fastest beveling machines with an automatic feed on the market. It is not only suitable for workshops, but also for assembly operations. It has a continuous working angle adjustment system. In addition, the machine is equipped with an automatic feed. Working with UZ15 Rapid is therefore very comfortable.

The unique 3D MANIPULATOR - unique design of the manipulator offers the possibility of a simple turning of the beveling machine by 180° for performing the X, K double-sided bevel. There is no need to use any tools for rotation. No need to handle material resulting in significant time savings.

The quick-connect system offers the ability to connect and disconnect the UZ15 RAPID from the 3D Manipulator within seconds without the use of any tools. This will be used in a situation where the 3D Manipulator cannot track the machine due to the poor quality of the working floor. The machine is then able to drive along the material itself. The 3D manipulator system enables the machine to adapt its working position to the current workplace situation, the UZ15 RAPID so-called „floats“ on the machined metal sheet and compensates for any unevenness of the floor or material deformation.

The 3D manipulator also ensures convenient transport of the machine across the workplace.

The lifting mechanism allows an easy adjustment of the working height of the machine.

Large castors guarantee comfortable overcoming obstacles and unevenness.

Working with or without the 3D Manipulator is possible.

Possibility to use 3D Manipulator as a fixed workstation for small pieces processing or as a UZ15 RAPID service bracket.

- Quick and easy to flip of the UZ 15 RAPID machine by 180° to create double-sided beveling in X or K shape
An operator does not need a crane to turn the material - great time savings
- Unique clamping system for the manipulator, few seconds removal without any use of tools
- The UZ 15 RAPID “floats” in the 3D MANIPULATOR and compensates for floor unevenness
- The 3D MANIPULATOR enables easy machine handling
- Required height adjustable with the lifting device
- The possibility to use the machine with without the 3D manipulator
- The possibility to use the 3D Manipulator a stationary mode
- The possibility to use the 3D Manipulator as a service station for the maintenance of UZ 15 RAPID
- Packed in a wooden crate

Technical data:

Weight of the whole set: 179 kg / 394 lb
 Dimensions: 1010 x 745 x 1326 mm
 39.76 x 29.33 x 52.2 in

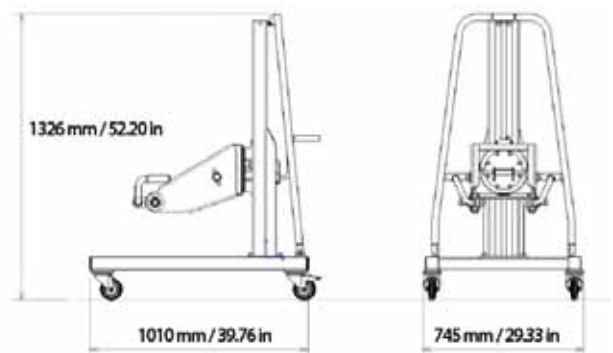

Included in price:

Beveling system UZ 15 RAPID including 3D MANIPULATOR.
 Tools for an operator.
 User manual.

Machine name:

Art. Nr.

Beveling system UZ15 RAPID including the 3D MANIPULATOR (3 Phase - 400 V)	1932
Beveling system UZ15 RAPID including the 3D MANIPULATOR (3 Phase - 480 V)	1937
Beveling system UZ15 RAPID including the 3D MANIPULATOR (3 Phase - 220 V)	1938





Bevelling system UZ18 HARDWORKER
 Maximum bevel width 18 mm / 0.71 in. Automatic feed.

UZ18 HardWorker



Incredibly silent operation



3D adaptive system



Art. Nr. 1980 (3 Phase - 400 V)
 Art. Nr. 1981 (3 Phase - 480 V)
 Art. Nr. 1982 (3 Phase - 220 V)

**3 BEVELERS
IN ONE**

Resistant worm gearbox

Continuous setting of 15° - 50° angle

Powerful 3-phase motor 750 W

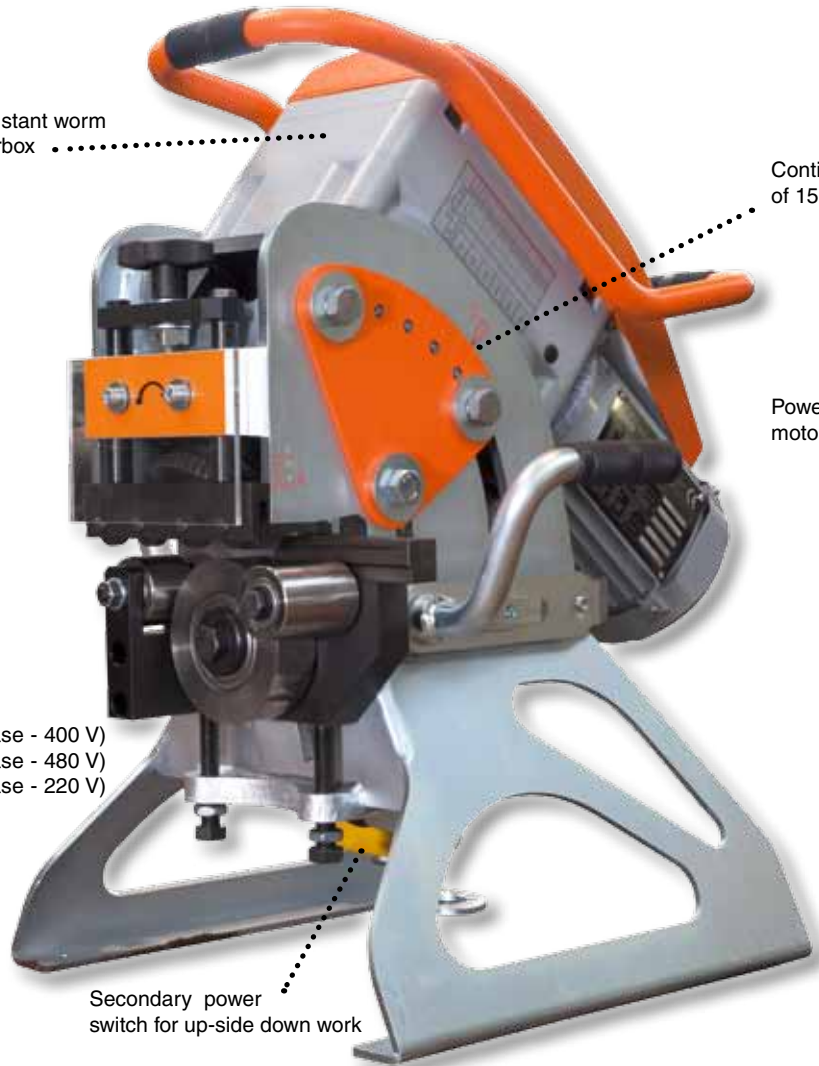

Secondary power switch for up-side down work



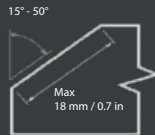

The UZ18 Hardworker machine is one of the most powerful beveling machines with the automatic feed on the market. It is suitable not only for workshops, but also for an assembly on-site. It has a continuous working angle adjustment system. Thanks to the special design of the drive system, the UZ18 Hardworker is also suitable for tougher materials. The machine is equipped with the automatic feed. Working with UZ18 Hardworker is therefore very comfortable.

- For conventional steel (up to 600 MPa / 87 022 PSI), brass, copper and aluminum
- For beveling material with minimum dimensions - width 70 mm / 2.75 in, length 150 mm / 5.9 in, thickness 6 mm / 0.23 in
- Thickness of bevelled material 6 to 40 mm / 0.23 to 1.57 in
- The bevel angle easily adjustable from 15° to 50° smoothly, without the need to replace any part
- Capable of performing double-sided bevel (X, K) without the need for material handling
- Easy connection to the 3D Manipulator for easier operation and handling
- Equipped with an automatic feed
- Stationary or mobile use
- The machine works with large workpieces without any support. Speed of 1.9 m/min / 6.23 ft/ min
- Smaller parts of the material are inserted directly into the machine
- Discounted price when purchasing UZ15 RAPID together with the 3D Manipulator
- Packed in a wooden crate

Technical data:

Max. bevel width:	18 mm / 0.71 in (600 MPa / 87 022 PSI)
Continuously adjustable angle:	15° - 50°
Thickness of bevel. material:	6 to 40 mm / 0.23 to 1.57 in
Engine:	750 W
Feed:	1,9 m/min. / 6.23 ft/min.
Weight:	110 kg / 242.5 lb
Dimensions (WxHxD):	438 x 719 x 644 mm 17.24 x 28.3 x 25.35 in

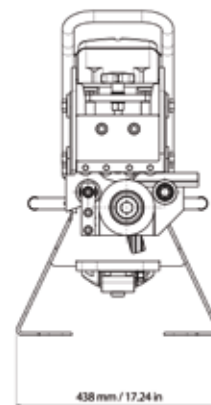
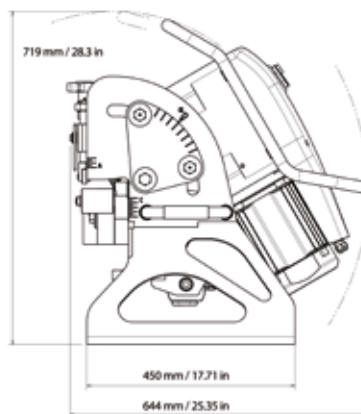

Included in price:

- Beveling system UZ18 Hardworker.
- Tools for an operator.
- User manual.

Machine name:

Art. Nr.

Beveling system UZ18 HARDWORKER (3 Phase - 400 V)	1980
Beveling system UZ18 HARDWORKER (3 Phase - 480 V)	1981
Beveling system UZ18 HARDWORKER (3 Phase - 220 V)	1982

Accessories:

Art. Nr.

ECO cutting tool - suitable for conventional steel	2137
ECO cutting tool - suitable for conventional steel - 2 + 1 free set	2134
PVD cutting tool - suitable for tougher materials	2142
PVD cutting tool - suitable for tougher materials - 2 + 1 free set	1936
PREMIUM Cutting Tool - coated TiN, suitable for conventional steel	2136
PREMIUM Cutting Tool - coated TiN, suitable for conventional steel - 2 + 1 free set	2132
3D Manipulator - allows to rotate the machine by 180° to create a two-sided bevel and facilitates the machine transport across the workplace.	1930
Beveling Solver - a portable calculator for cutting calculations for N.KO Machines (see page 44 - 45)	1900



Art. Nr. 2136



Art. Nr. 2134



Art. Nr. 1900



Art. Nr. 2137



Art. Nr. 1936



3D adaptive system



Art. Nr. 1930

UZ18 HardWorker

+ 3D Manipulator set



3D adaptive system compensates for the unevenness of the floor and enables positioning of the machine according to the situation at the workplace



Silent operation



3D adaptive system



3 BEVELERS
IN ONE



3 BEVELERS
IN ONE



Rotary mechanism allows performing both-side beveling without any need for material handling

Height adjustment of the machine position

Quick-fastening machine system quick-connect

Art. Nr. 1983 (3 Phase - 400 V)
Art. Nr. 1984 (3 Phase - 480 V)
Art. Nr. 1985 (3 Phase - 220 V)

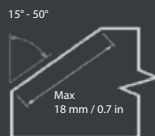

The UZ 18 Hardworker is one of the most powerful beveling machines with the automatic feed on the market. Suitable not only for workshops, but also for an assembly on-site. It is equipped with the continuous working angle adjustment system.

Thanks to the special design of the drive system, the UZ 18 Hardworker is also suitable for tougher materials. The machine is equipped with the automatic feed. Therefore, working with UZ 18 Hardworker is very comfortable.

Unique MANIPULATOR 3D - unique design of the manipulator offers the possibility of a simple turning of the beveling machine by 180° for performing the X, K double-sided bevel. No tools required to rotate. No need for material handling = significant time savings. The quick-connect system offers the option to connect and disconnect the UZ 18 Hardworker from the 3D Manipulator within seconds without the use of any tools. You will appreciate this in a situation where the 3D Manipulator cannot follow the machine due to the poor quality of the working floor. The machine is then able to travel along the material itself. The 3D manipulator system allows for the machine to adapt its working position to the actual workplace situation.

The UZ 18 Hardworker "floats" on a machined sheet metal and compensates for any floor unevenness or material deformation.

The 3D manipulator also ensures convenient transport of the machine at the workplace.

The lifting mechanism allows easy adjustment of the working height of the machine.

Large castors guarantee comfortable overcoming of obstacles and unevenness.

Optional working with or without 3D Manipulator.

Possibility to use 3D Manipulator as a fixed workstation for small pieces processing or as a UZ18 Hardworker service bracket.

- The manipulator enables a quick and easy turning of the UZ 18 Hardworker by 180° to form the X- or K- shaped double-sided bevel. An operator does not need a crane to rotate the material - significant time savings
- A unique clamping system allows the UZ 18 Hardworker to be clamped and then removed from the manipulator within a few seconds without the use of tools
- The UZ 18 Hardworker "floats" in 3D MANIPULATOR and compensates for floor unevenness
- 3D MANIPULATOR for easy handling of the machine
- Required height adjustable with the lifting device
- The possibility to use the machine with without the 3D manipulator
- The possibility to use the 3D Manipulator a stationary mode
- Optional use of the Manipulator 3D as a stationary station
- Optional use of the Manipulator 3D as a service station for the maintenance of the UZ18 Hardworker
- Packed in a wooden crate

Technical data:

Weight of the whole set: 204 kg / 449.7 lb
 Dimensions: 1010 x 745 x 1326 mm
 39.76 x 29.33 x 52.2 in

Included in price:

Beveling system UZ18 HARDWORKER including the 3D MANIPULATOR
 Tools for an operator.
 User manual.

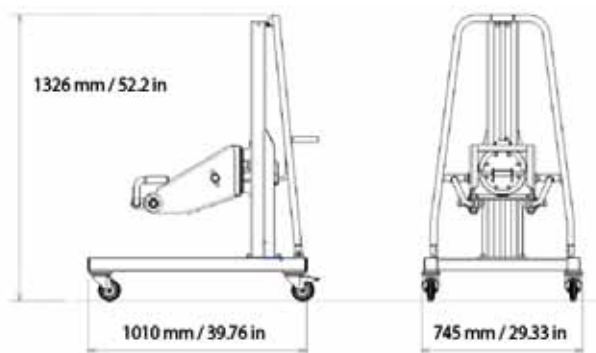

Name of machine:

Art. Nr.

Beveling system UZ18 HARDWORKER including the 3D MANIPULATOR (3 Phase - 400 V)	1983
Beveling system UZ18 HARDWORKER including the 3D MANIPULATOR (3 Phase - 480 V)	1984
Beveling system UZ18 HARDWORKER including the 3D MANIPULATOR (3 Phase - 220 V)	1985



UZ29 Speeder



Incredibly quiet operation



3D adaptive system



3 BEVELERS
IN ONE

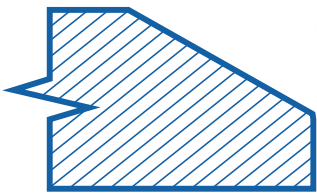

Bevel width 18 mm / 0.7 in - in first cut by feeding speed 1.8 m / min. / 5.9 ft/min.

Compensation of bevel angle

Worm-gear unit without a need for changing oil

Powerful 3-phase 1500 W motor

Replaceable angle KIT



Art. Nr. - following page





UZ29 SPEEDER machine is one of the largest and most powerful machines in the field of rotary cutting bevelling machines. The machine is equipped with an automatic feed and can be used as a stationary machine designed for large and small volumes of smaller workpieces. At the same time it can be used as a mobile bevelling system when the machine moves along the machined steel sheet at a rate of almost two meters per minute. The UZ29 SPEEDER machine is capable of machining both, standard and stainless steel. The machine has a supersilent drive not increasing the noise at the workplace.

In addition it is possible to flip the entire machining unit upside down and create bevels for X and K form of the welds without handling machined material. This application is made possible by the rotary mechanism of the 3D manipulator, which is a standard machine equipment.

- For conventional steel (up to strength 700 MPa / 101 526 PSI), stainless steel, brass, copper and aluminum materials
- The bevelled material thickness 6 to 60 mm / 0.23 to 2.36 in
- Variable bevel angle with replaceable arms/kits for each given angle
- Double-sided bevel (X, K), without any need for material handling
- Suprisingly silent drive
- Equipped with an automatic feed
- Stationary or mobile use
- 3D manipulator for any unevenness or deformations in the length of machined material. It also allows to work on uneven floor
- Smaller parts of the material are inserted directly into the machine
- Single operator machine
- Packed in a wooden crate

Technical data:

Max. bevel width:	29 mm / 0 to 1.14 in < 400 MPa / 58 015 PSI 25 mm / 0 to 0.1 in > 400 MPa / 58 015 PSI
Bevel angle:	30°, 45°, 22.5°, 37.5°, 50° (replaceable KIT)
The thickness of the bevel. material:	6 - 60 mm / 0.23 to 2.36 in
Engine:	1500 W
Feed:	1.8 m/min. / 5.9 ft/min.
Weight:	205 kg / 452 lb
Dimensions:	1010 x 745 x 1326 mm 39.76 x 29.33 x 52.2 in

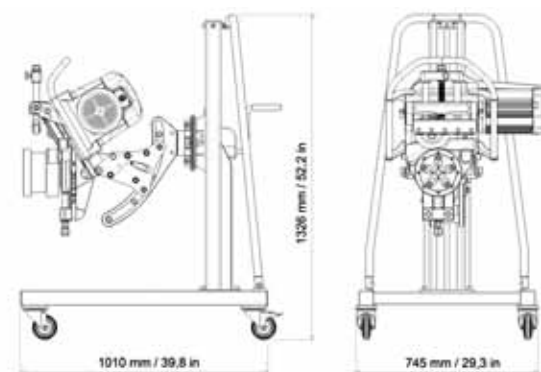

Included in the price:

Bevelling system UZ29 SPEEDER
Tools for an operator.
User manual.

Machine name:	Art. Nr. - 400V 3 phase	Art. Nr. - 480V 3 phase	Art. Nr. - 220V 3 phase
Bevelling system UZ29 SPEEDER - set (KIT 30° + 45°)	1962	1903	1907

Accessories:	Art. Nr.
ECO cutting tool - suitable for conventional steel	1970
ECO cutting tool - suitable for conventional steel - 2 + 1 free set	1972
PVD cutting tool - suitable for tougher materials	1971
PVD cutting tool - suitable for tougher materials - 2 + 1 free set	1973
Separate KIT 22,5°	1966
Separate KIT 30°	1964
Separate KIT 37,5°	1967
Separate KIT 45°	1965
Separate KIT 50°	1968
Bevelling Solver - a portable calculator for cutting calculations for N.KO Machines (see page 44 - 45)	1900



Art. Nr. 1970



Art. Nr. 1971



Art. Nr. 1972



Art. Nr. 1965



Art. Nr. 1900

UZ30 Express

Fast and precise adjustment of machine by adjusting gauges

Gravity feed mechanism with the optional feed rate setting

Ball table facilitates material handling

Angle setting

A sturdy design for stability and durability of the machine

Art. Nr. 25999 (3 Phase - 400 V)
Art. Nr. 25997 (3 Phase - 480 V)
Art. Nr. 25998 (3 Phase - 220 V)

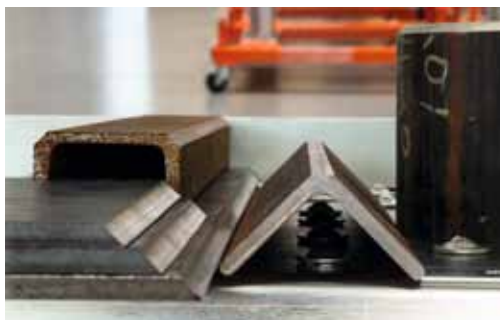

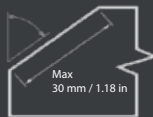

Stationary UZ30 EXPRESS is one of the best solutions for bevelling large volumes of smaller and small workpieces or long, narrow steel strips. **UZ30 EXPRESS** can be used not only for bevelling, but also for deburring. Thanks to the unique geometry of the cutter the feed rate can be set up to the speed of 3.5 m/min. / 11.5 ft/min. For longer workpieces it is possible to equip the machine with an additional input and output table which extends the workspace to remarkable 2 824 mm / 111.18 in.

- The machine designed for bevelling steel, aluminum, copper and other materials, flat bars, tubes, shaped bevelling
- Bevelling by milling - high quality bevel (mirror finish)
- Feed control by a variator
- The cutter's speed is controlled by frequency converter
- Another optional accessories for pipe bevelling
- The possibility of extending the work table (input and output table - a total of 2824 mm / 111.18 in including the base table)
- Fast and precise adjustment of the machine with the gauges
- Packed in a wooden crate

Technical data:

Approximate values of the maximum bevel width:

at 30° 30 mm / 1.18 in
 at 45° 20 mm / 1.10 in
 at 60° 17 mm / 0.67 in

Adjusting the bevel angle:

30 - 60° (continuous)

Thickness of the material:

3 to 100 mm / 0.11 to 3.93 in

Bevelling pipes:

Ø102 - 156 mm / Ø4.01 - 6.14 in

Cutting head engine:

4000 W

Cutting head speed:

Adjustable (frequency convertor)

Feed rate:

0 - 5500 rpm
 0,6 - 3,5 m/min. / 1.96 - 11.5 ft/min.

Weight:

400 kg / 881.8 lb

Dimensions:

825 x 1200 x 1615 mm

Number of cutting inserts:

5 pcs

Included in the price:

Beveling system UZ30 EXPRESS

Tools for an operator, adjusting scales.

User manual.

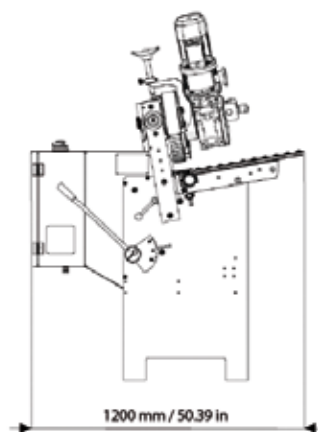
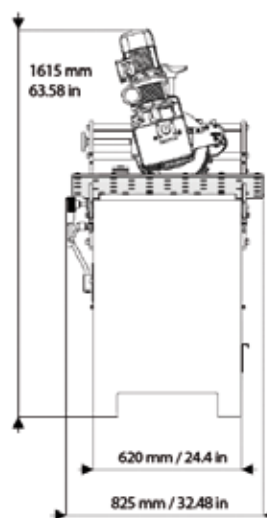

Name of machine:

	Art. Nr.
Bevelling system UZ30 EXPRESS (3 Phase - 400 V)	25999
Bevelling system UZ30 EXPRESS (3 Phase - 480 V)	25997
Bevelling system UZ30 EXPRESS (3 Phase - 220 V)	25998

Accessories:

	Art. Nr.
Cutting head (incl. clamping wedges and screws)	25910
Cutting inserts premium (pack of 10 pcs)	25907
Input and output table with adjustable stops (table length 1m/pc)	25908
Fixture for bevelling pipes Ø102 - 156 mm	25902
Adjusting gauges for machine adjustment	25916
Wedge for fastening of the inserts	25917
Screw for the wedge	25914
Milling head for stainless steel	25911
Cutting inserts for stainless steel	25909



Art. Nr. 25908



Art. Nr. 25916



Art. Nr. 25902



Art. Nr. 25910



Art. Nr. 25907

UZ50 Triumph



3D adaptive system

3 BEVELERS
IN ONE



Cutter powerful motor - 4000 W

Remote control can be operated hand-held or clamped to the machine

Quick connect machine system

Rotary mechanism allows to perform two-sided bevelling without a need for material handling

Height adjustment of the machine position.

Dual system of synchronized feed units

3D adaptive system compensates for inequality of floor and allows for the adjustment of machine position according to the situation at workplace

Art. Nr. 1940 (3 Phase - 400 V)
Art. Nr. 1952 (3 Phase - 480 V)
Art. Nr. 1953 (3 Phase - 220 V)





Bevelling system UZ 50 Triumph is another of the series of unique solutions developed N.K.O Machines. Basically, three bevelling systems are combined in a single machine. UZ50 Triumph can be used as a mobile beveller, which moves along the beveled material at the speed up to 1.2m/min, 3.93 ft/min. The range of the beveling angle is 15°-50°. In addition, it is possible to flip the entire machining unit upside down and create bevels for X and K form of the welds without handling machined material. This application is made possible by the rotary mechanism of the 3D manipulator, which is a standard machine equipment. Finally, the machine can be rebuilt for a stationary beveller with a special equipment UZP 30. This mode is intended for processing smaller parts with a minimum length of the bevel edge 200mm, 8.19 in.

Adjustable cutting conditions enable the UZ50 to machine otherwise difficult materials like stainless steel, Hardox (armored steel), Weldox and Domex on top of mild carbon steel.

3D manipulator allows to adapt UZ50 for any unevenness or deformations in the length of machined material. It also allows to work on uneven floor.

If needed it is possible to disconnect the UZ50 from the manipulator completely due to the quick-connect function within few seconds and use the UZ50 separately.

- Automatic feed with continuous adjustment of the feed rate in the range of 0 - 1,2 m/min. / 0 - 3.93 ft/min
- High speed milling tool equipped with cutting inserts with extended life
- The variable adjustment of the desired angle in the range 15°-60 ° without having to replace any parts
- All electronic equipment is closed in the dust-tight cabinet with increased vibration resistance
- Equipped with the most modern safety features
- The possibility to buy ASP – active smart protection
- The machine cuts problematic materials - e.g., stainless steel, Hardox, Weldox a Domex
- Packed in a wooden crate

Technical data:

Max. bevel width: 62 mm / 2.44 in
 Adjusting the bevel angle: 15° - 60° (continuous)
 Material thickness: 7 to 80 mm / 0.27 to 3.15 in
 Motor of cutting head: 4000 W
 Feed speed: 0 - 1,2 m/min. / 0 - 3.93 ft/min.
 Weight: 175 kg / 385.8 lb
 Dimensions: 1010 x 745 x 1326 mm
 39.76 x 29.33 x 52.2 in
 Number of cutting inserts 5 pcs

Included in the price:

Bevelling system UZ50 TRIUMPH.
 Tools for an operator.
 User manual.

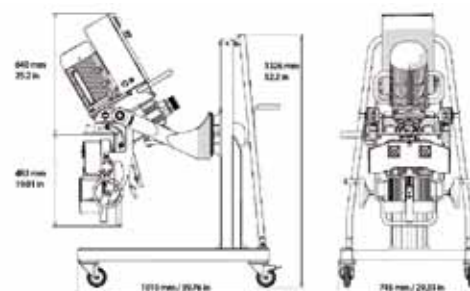

bevel angle α	max. width of the bevel (P)
15°	62 mm / 2.44 in (recommended in 3 passes)
20°	62 mm / 2.44 in (recommended in 4 passes)
25°	56 mm / 2.2 in (recommended in 4 passes)
30°	52 mm / 2.04 in (recommended in 5 passes)
35°	51 mm / 2 in (recommended in 5 passes)
40°	51 mm / 2 in (recommended in 5 passes)
45°	50 mm / 1.97 in (recommended in 5 passes)
50°	51 mm / 2 in (recommended in 5 passes)
55°	51 mm / 2 in (recommended in 5 passes)
60°	52 mm / 2.04 in (recommended in 5 passes)

B=max. 5 mm / 0.2 in (1 pass)

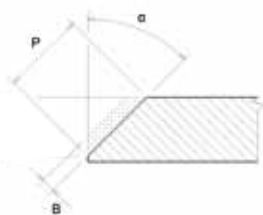

Machine name:

	Art. Nr.
Bevelling system UZ50 TRIUMPH - including 3D manipulator (3 Phase - 400 V)	1940
Bevelling system UZ50 TRIUMPH - including 3D manipulator (3 Phase - 480 V)	1952
Bevelling system UZ50 TRIUMPH - including 3D manipulator (3 Phase - 220 V)	1953

Accessories:

	Art. Nr.
ECO Cutter head 5 inserts (Insert´s screw included)	1946
ECO Cutting inserts (pack of 10 pcs)	1945
PREMIUM Cutting head 9 inserts (Insert´s screw included)	1943
PREMIUM Cutting inserts (pack of 10 pcs)	1955
Plate fence for adjusted for HARDOX bevelling and other wear-resistant materials	1949
ASP active, intelligent machine protection against overload	1956
UZP 30 additional table for processing small pieces	1942
Screw for the inserts	1947
Bevelling Solver - a portable calculator for cutting calculations for N.K.O Machines (see page 44 - 45)	1900

ASP - Active intelligent machine protection against overload

It is a system monitoring immediate machine load and machining conditions.

If the ASP system detects overload of the machine for reasons of tool wear, too high feed rate, or improperly adjusted machine, the ASP system informs the operator of this fact actively by flashing lights on the remote control.

If the operator fails to do steps leading to reduce load on the machine within 20 seconds (resizing removal, replacement of cutting tips, reducing speed), the system disconnects the supply of feed wheels and the machine stops. Beware, the system does not protect against the shock overload! The ASP system is only available for purchase as an accessory with a new machine.

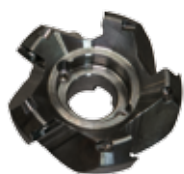

Art. Nr. 1946



Art. Nr. 1943



Art. Nr. 1945

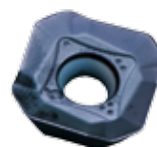

Art. Nr. 1955



Art. Nr. 1900



Bevelling system UZ50 TRIUMPH + UZP 30 set
 Maximum bevel width 30 mm / 1.18 in. Automatic feed.

UZ50 Triumph

+ UZP30 set



3 BEVELERS
IN ONE

set UZ 50 TRIUMPH + UZP30

Hardened work desk

Storage area for remote control

Protection against flying chips

Supporting structure of the desk UZP 30



Art. Nr. 1941 (3 Phase - 400 V)
 Art. Nr. 1954 (3 Phase - 480 V)
 Art. Nr. 1957 (3 Phase - 220 V)



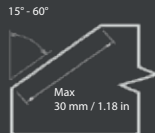

The UZP 30 product allows modification of UZ50 TRIUMPH into the stationary beveling station for processing smaller workpieces or narrow steel strips, it can be purchased separately or in a set with the machine UZ50 TRIUMPH. The UZ50 TRIUMPH with this accessory has all the advantages of UZ50 TRIUMPH. For example machining of harder material such a Hardox, armored steel and etc. But it can also be used for mild carbon steel. The minimum edge length of the bevelled material must be at least 250 mm / 12 in.

- Use with the machine UZ50 Triumph
- The variable adjustment of the desired angle of 20° - 60° without having to replace any parts
- Beveling small size workpieces that are inserted directly into the machine. The whole machining process is then automatic without having to hold the workpiece
- Equipped with the most modern safety features
- Possibility to buy ASP – active smart protection
- Cuts problematic materials - e.g., stainless steel, Hardox Weldox and Domex
- Packed in a cardboard box. (UZ50 TRIUMPH is Packed in a wooden crate).

Technical data:

Max. bevel width: 30 mm / 1.18 in
 Adjusting the bevel angle: 20° - 60° (continuous)
 Material thickness: 7 to 70 mm / 0.27 to 2.75 in
 Cutting head motor: 4000 W
 Feed speed: 0 - 1,2 m/min. / 0 - 3.93 ft/min.
 Weight: 202 kg / 445 lb
 Dimensions: 1010 x 745 x 1326 mm
 39.76 x 29.33 x 52.2 in
 Number of cutting inserts 5 pcs

Included in the price:

Beveling system UZ50 TRIUMPH + UZP30 set
 Tools for an operator.
 User manual.

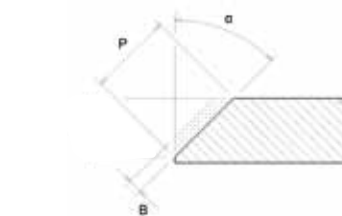

bevel angle α	max. bevel width (P)
20°	20 mm / 0.79 in (recommended in 2 passes)
25°	24 mm / 0.95 in (recommended in 3 passes)
30°	26 mm / 1.02 in (recommended in 3 passes)
35°	27 mm / 1.06 in (recommended in 4 passes)
40°	30 mm / 1.18 in (recommended in 4 passes)
45°	30 mm / 1.18 in (recommended in 4 passes)
50°	30 mm / 1.18 in (recommended in 4 passes)
55°	30 mm / 1.18 in (recommended in 4 passes)
60°	28 mm / 1.10 in (recommended in 4 passes)

B=max. 4mm / 0.15 in (1 pass)

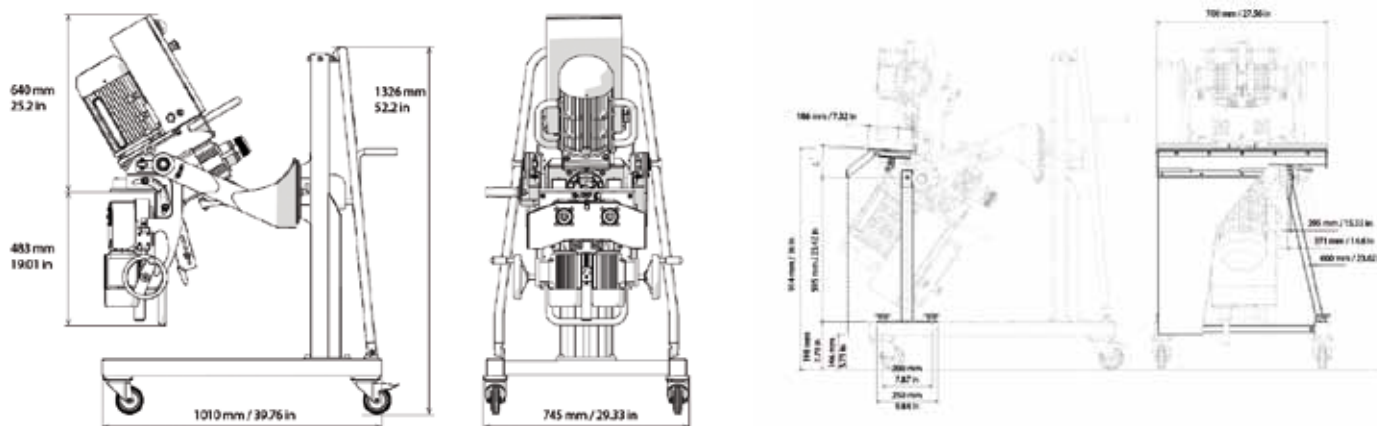

Machine name:

	Art. Nr.
Beveling system UZ50 TRIUMPH (incl. 3D manipulator) + UZP30 set (3 Phase - 400 V)	1941
Beveling system UZ50 TRIUMPH (incl. 3D manipulator) + UZP30 set (3 Phase - 480 V)	1954
Beveling system UZ50 TRIUMPH (incl. 3D manipulator) + UZP30 set (3 Phase - 220 V)	1957

Accessories:

	Art. Nr.
PREMIUM Cutting head 9 inserts RECOMMENDED when using UZP30!	1943
ECO Cutting inserts (pack of 10 pcs)	1945
PREMIUM Cutting inserts (pack of 10 pcs)	1955
Vertical guide plate adapted for beveling HARDOX and other wear-resistant materials	1949
ASP active smart protection against overloading of the machine	1956
Screw for the inserts	1947
Beveling Solver - a portable calculator for cutting calculations for N.KO Machines (see page 44 - 45)	1900



Art. Nr. 1943



Art. Nr. 1945

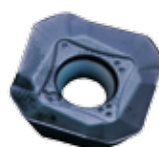

Art. Nr. 1955



Art. Nr. 1900

Bevelling Solver

A portable calculator for cutting calculations for NKO Machines

Soft rubber protection sleeve

Touch screen

Equipped with magnets for fastening on the machine's body



Art. Nr. 1900





- Touch screen
- Rechargeable battery
- 13 language modes
- Metric or imperial units
- MicroUSB port for updates and repairs
- Soft rubber protection sleeve prevents damages and provides a better grip
- Equiped with magnets for fastening on the machine's body

It works with:

- UZ12 Ultralight
- UZ15 Rapid
- UZ18 Hardworker
- UZ29 Speeder
- UZ50 Triumph
- UZ50 Triumph + UZP30



Machine name: Beveling Solver - a portable calculator for cutting calculations for N.KO Machines	Art. Nr. 1900
--	-------------------------

Compatible with



Stinger 300





86 - 269mm
(3.38" - 10.59")



The Stinger 300 pipe beveling machine is designed for portable use in pipe machining operations and it can be used efficiently by a single operator. The Stinger 300 is a heavy-duty ID mounted pipe beveler utilizing self-centering expandable mandrels to provide quick and proper alignment to a pipe or a tube prior to machining operations.

The Stinger 300 can bevel, face and counter-bore in a single operation, making all these weld prep operations quick and simple. EasyLOCK - The tool bit is fastened by one screw anywhere on the holder. The holder is equipped with a scale for easier tool's centering.

The Stinger 300 can be used with three or two tool's holders only depending on the required bevelling job.

- Simultaneous bevel, face, and counter-bore
- EasyLOCK - locking of the tool bit by one screw
- Centering scale
- Standard or custom-made tool bits
- J-Bevel tool bits available for high welding efficiency on thicker walled pipe
- Centering screw to eliminate the potential vibrations.

Technical data:

Number of the mandrels:	2 pcs
Mandrel A. ID range:	86 - 269 mm (3.38" - 10.59")
Mandrel B. ID range:	36 - 86 mm (1.41" - 3.38")
Wall thickness max.:	15 mm (0.59")
Motor electric:	1800 W / 2 gears + RPM control / MT3
Weight with A mandrel:	36,6 kg (80.6 lb)
Weight with B mandrel:	31 kg (68.3 lb)
Weight of additional stand:	5,8 kg (12.8 lb)

Included in the price:

- Pipe bevelling system Stinger 300
- Mandrel A including a set of compensating jaws
- Tool holder (2 pcs)
- Tools for an operator
- User manual



Name of machine:

	Art. Nr.
Pipe bevelling system Stinger 300 (1Phase - 230 V)	30002
Pipe bevelling system Stinger 300 (1Phase - 120 V)	30004

Accessories:

	Art. Nr.
Mandrel A. - ID range: 86 - 269 mm (3.38" - 10.59")	30006
Mandrel B. - ID range: 36 - 86 mm (1.41" - 3.38")	30005
Tool holder	30007
Additional stand	30010
Motor 230V	30008
Motor 120V	30009
Set of Standard cutting tools - 0°, 30°, 37°, 15°	603
Standard cutting tool - 0°	603_01
Standard cutting tool - 30°	603_02
Standard cutting tool - 37°	603_03
Standard cutting tool - 15°	603_04
Set of Premium cutting tools - 0°, 30°, 37°, 15°	604
Premium cutting tool - 0°	604_01
Premium cutting tool - 30°	604_02
Premium cutting tool - 37°	604_03
Premium cutting tool - 15°	604_04



Art. Nr. 30007

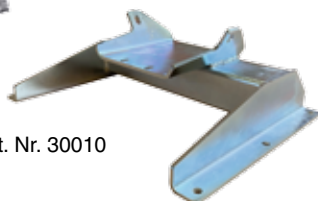

Art. Nr. 30010



Art. Nr. 30008



cutting tools



Art. Nr. 30006



Art. Nr. 30005

Pasovec75 Runner

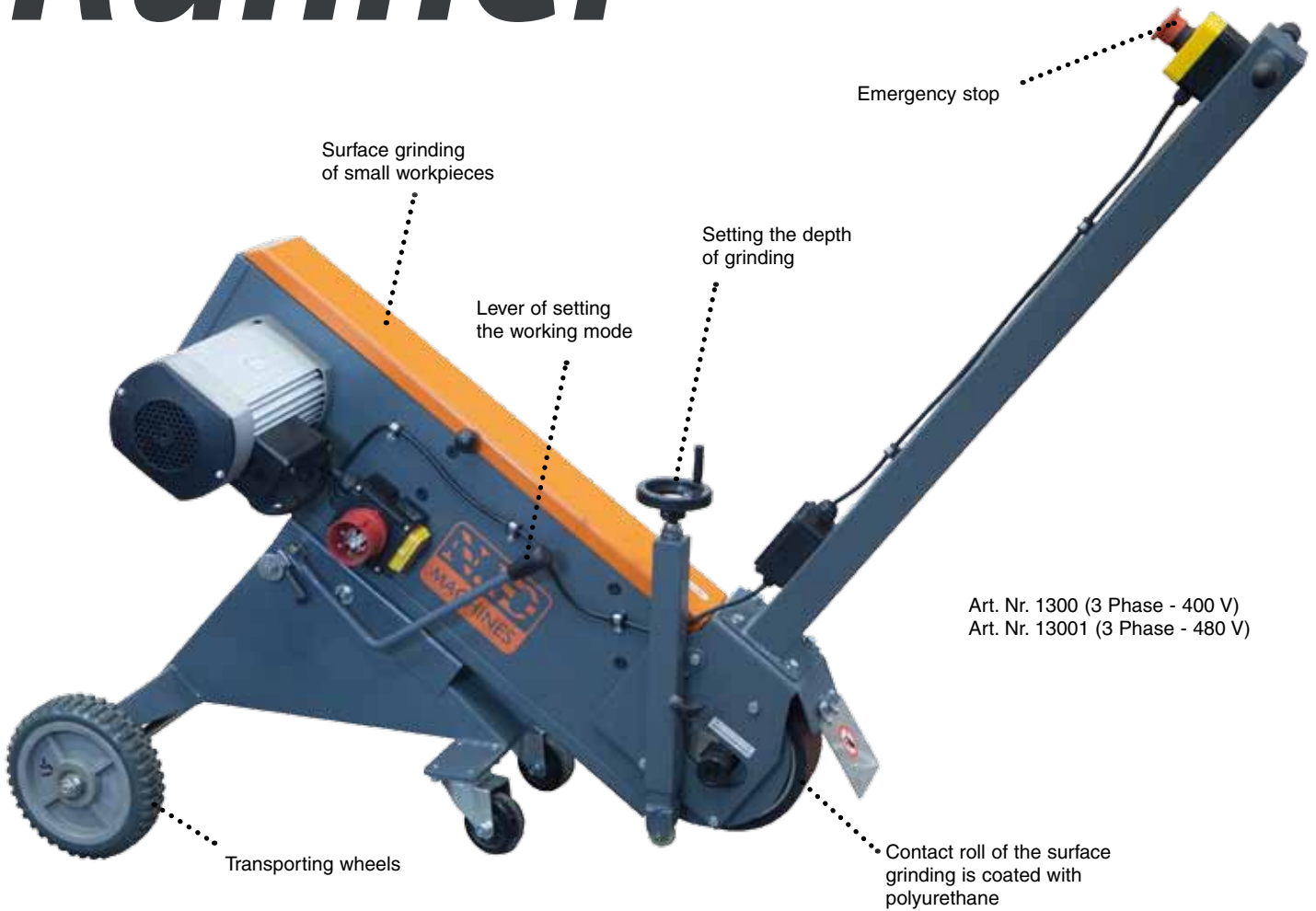



Pasovec75 RUNNER - the special belt grinder developed for surface grinding applications, in particular for grinding welds in the material surface. Pasovec75 Runner removes undesirable layer caused by the rolling of metal sheets or after metal sheet cutting using plasma or oxygen. The machine has a stable chassis, a quick adjustment mechanism and a depth stop for precise adjustment of the depth of grinding.

- Innovative, multifunctional machine
- Continuous setting of the grinding depth
- System for the quick deactivation of work mode
- Station of the surface grinding of small workpieces
- Low operational costs
- Packed in a wooden crate

Technical data:

Grinding belt width	75 mm / 2.95 in
Grinding belt length	2000 mm / 78.74 in
Engine	3000 W
Number of speeds	1 - speed
Grinding belt peripheral speed	30 m/s / 98.42 ft/s
Dimensions (W x H x D)	610 x 944 x 1419 mm 24 x 37.16 x 55.86 in
Weight	70 kg / 154 lb

Included in price:

- 1 pc Mobile belt grinder Pásovec75 Runner
- 1 pc Grinding belt 75 x 2000 mm / 2.95 x 78.74 in, grain 80
- User manual.

Name of machine:

Art. Nr.

Mobile belt grinder Pasovec75 Runner (3 Phase - 400 V)	1300
Mobile belt grinder Pasovec75 Runner (3 Phase - 480 V)	13001

Accessories:

Art. Nr.

Universal grinding belt, dimensions 75 x 2000 mm / 2.95 x 78.74 in, grain 36 or 60, 80, 120, package of 10 pcs	PAS STANDARD ZK75x2000
Grinding belt for higher grade materials (stainless steel), dimensions 75 x 2000 mm / 2.95 x 78.74 in, grain 36 or 60, 80, 120, package of 10 pcs	PAS TOP Quality XK75x2000

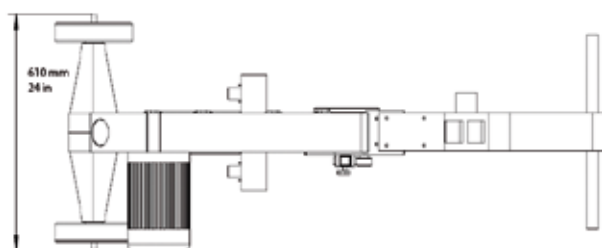
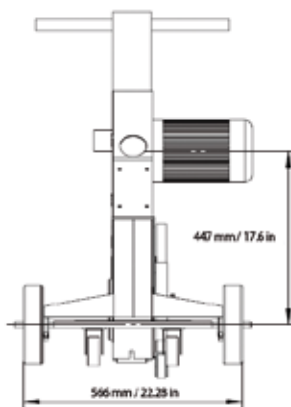
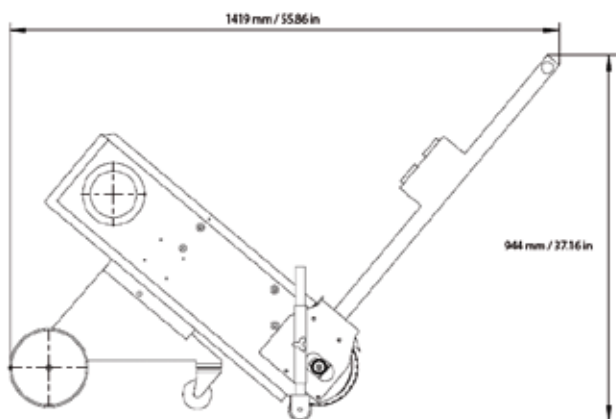

Mag Brush Maxx Large

- Magnetic sweeper
- Width of the collecting bar 17,7" / 450 mm
- Collects all magnetic materials, such as steel chips, metal waste etc
- Magnetic sweeper is equipped with wheels
- You can release collected material by the simple feed of the handle part up
- Telescopic pole for comfortable use
- Packed in a paper box

Technical data:

Lenght of a magnetic bar 450 mm / 17.71 in
 Adjustable telescopic handle 920 -1250 mm / 36.22 - 49.21 in
 Weight 5,5 kg / 12 lb

Name: Magnetic sweeper Mag Brush Maxx Large	Art. Nr. NMF0107
---	----------------------------

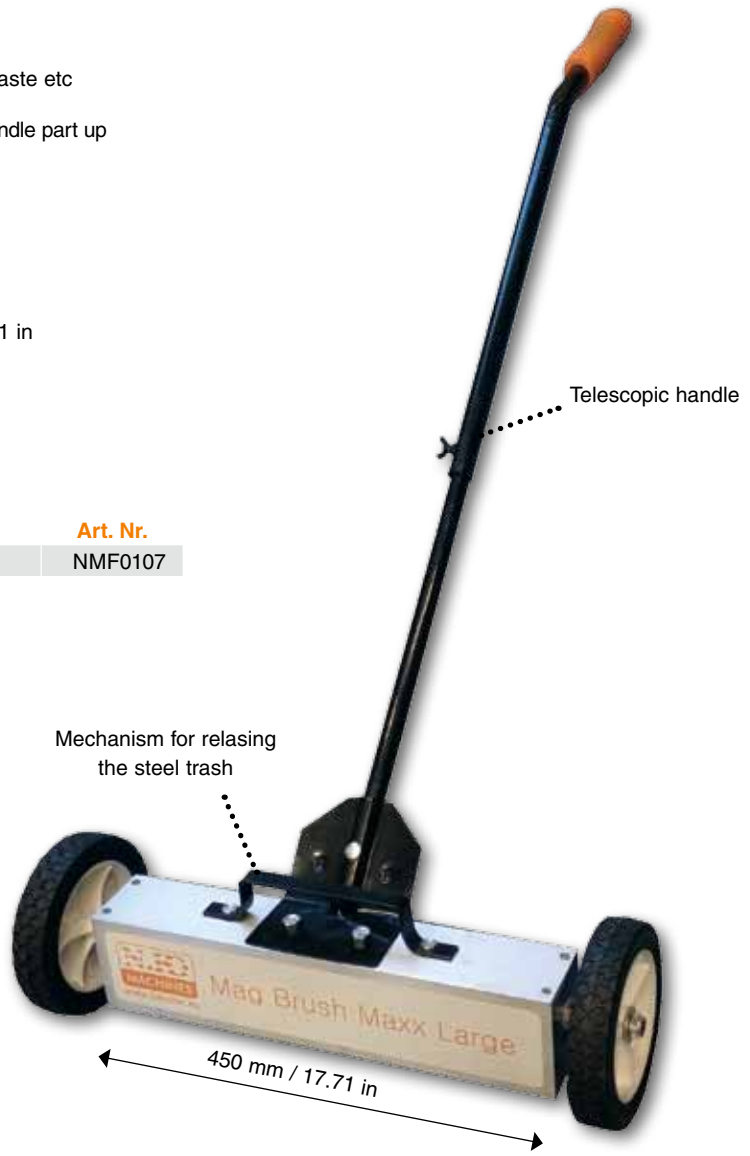

Mag Brush

- Collects all magnetic materials, such as steel chips, metal waste etc
- Release collected material by the simple feed of the handle part up
- Packed in a paper box

Technical data:

Lenght of a magnetic bar 180 mm / 7.1 in

Name: Mag Brush	Art. Nr. 18654
---------------------------	--------------------------

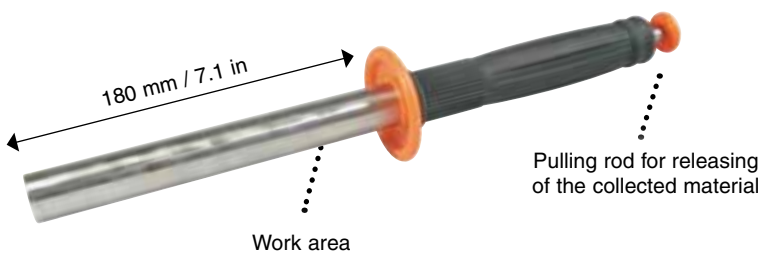

Cutters	Art. Nr.
Cutting tool ECO for the machine CEVISA - CHP6, CHP12 and other bevelling systems	2135
Cutting tool PVD for the machine CEVISA - CHP6, CHP12 and other bevelling systems	2235
Cutting tool ECO for the machine GULLCO - KBM 18	2133
Cutting tool PVD for the machine GULLCO - KBM 18	2233



Art. Nr. 2135



Art. Nr. 2133

Expected life and the recommended care for the tool:

Tools intended for machining by rotary shear are designed for materials with the maximum strength of Rm up to 600 MPa / 87 022 PSI. Upon the compliance with all conditions specified in the instruction manual, the tool life may be up to 4000 m / 13 123 ft and more.

Realistically the life is about 2000 – 3000 m / 6561 - 9842 ft. A tool life is influenced by several factors:

Material and its preparation

As already mentioned it is necessary to adhere to the maximum strength of the machined material.

When bevelling materials with higher than allowable strength the tool life rapidly decreases, but there is also a risk of the destruction of the tool or damaging the drive unit.

The tool life can also be affected by the preparation of the material before machining. If the material at your workshop is cut by burning, you should clean the edges intended for bevelling by angle grinder.

When burning, especially when plasma burning, edges of the material might be little bit hardened.

This can have a significant impact on the ultimate tool life.

Care for tool

The maintenance of the tool and especially the care for the tool has significant influence on the life of the tool.

During bevelling, it is important to check sharpness of the tool on a regular basis and if it is blunt, it is necessary to sharpen it immediately.

If you continue to work with a blunt tool chipping or destruction of the tool might occur.

Working procedure

The machining procedure is important.

Generally, when implementing the maximum possible reductions (bevel edge width) machining must be divided into two cuts.

This whole issue is described in detail in the machine user manual.



Atlanta - USA



Bengaluru - India



Melbourne - Australia



Brno - Czech Republic



Kielce - Poland



Moscow - Russia

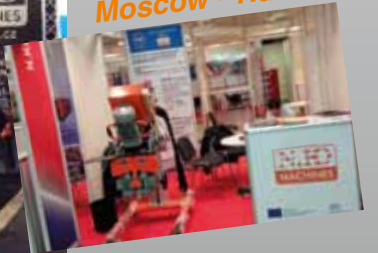

Beijing - China



Johannesburg - SA



Bangkok - Thailand



Jakarta - Indonesia



Istanbul - Turkey



Hannover - Germany



Development and production



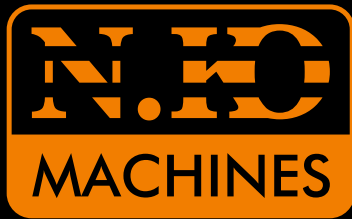

www.beveler.eu
www.bevelerUSA.com

MANUFACTURER ADDRESS



N.K.O spol. s r.o.
a Member of Richtr Group
producer of bevelling machines
Táborská 398/22
293 01 Mladá Boleslav
Czech Republic, European Union
VAT NUMBER: CZ26161109

email: nko@nko.cz

website: www.beveler.eu

English: +420 326 772 001

Spanish: (+34)900953423

Portuguese: (+351)210202803



AUTHORIZED PARTNER USA & CANADA



BEVELER USA INC.
a Member of Richtr Group
6538 Collins Avenue, #286
Miami Beach
FL 33141
USA

email: sales@bevelerusa.com

website: www.bevelerUSA.com

Toll Free: 1-800-973-1138

Office phone: 1-412-452-2563

WAREHOUSE / WORKSHOP / OFFICE

BEVELER USA INC.
511 Parkway View Dr,
Pittsburgh, PA 15205

